

CHAIN IDLER PULLEY REPLACEMENT

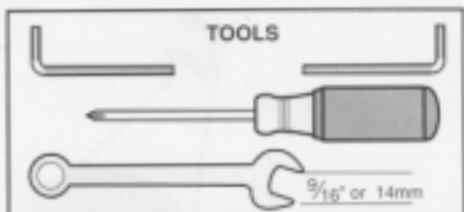

CII Part # PN 1717

Concept II © 1995 Concept II, Inc.
MORRISVILLE, VERMONT USA

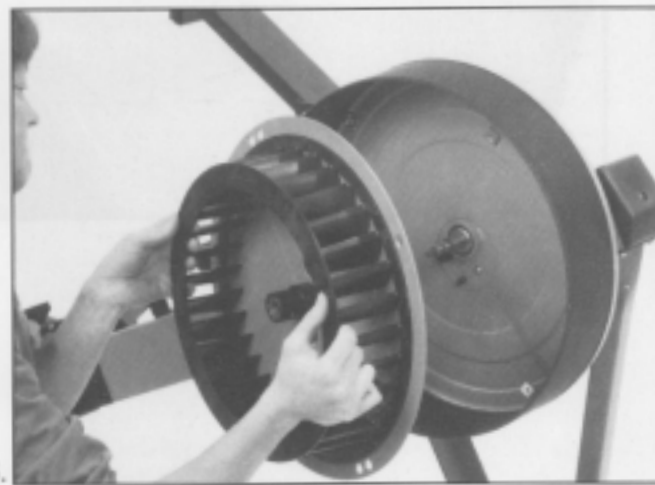
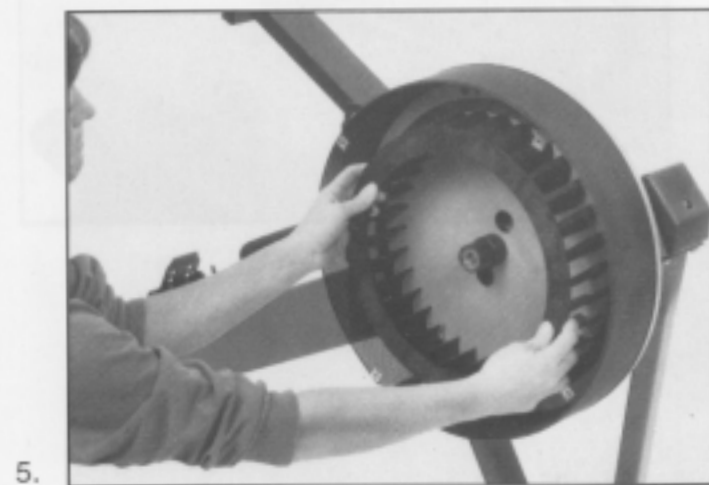
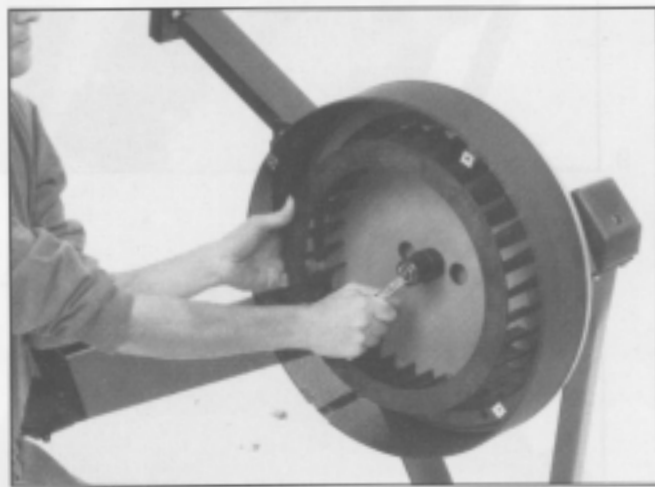
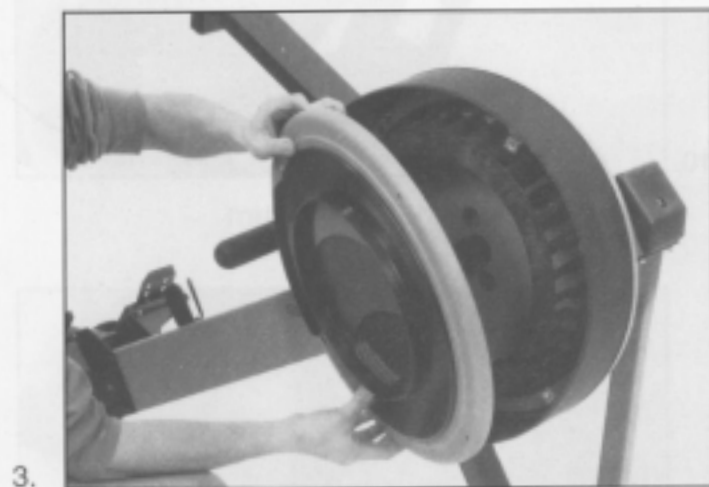
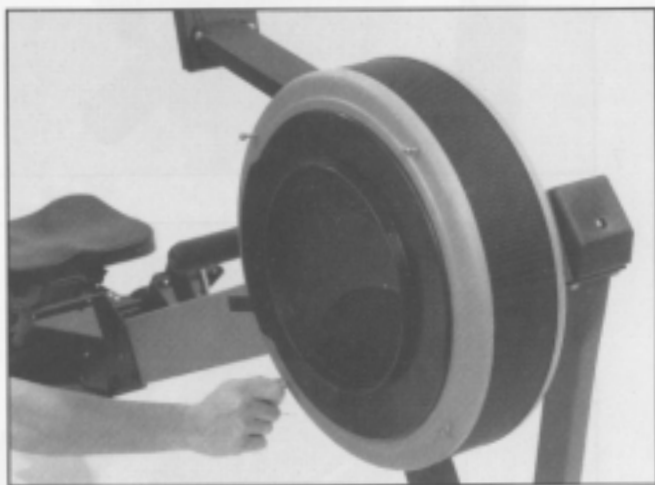

CHAIN IDLER PULLEY REPLACEMENT

7.

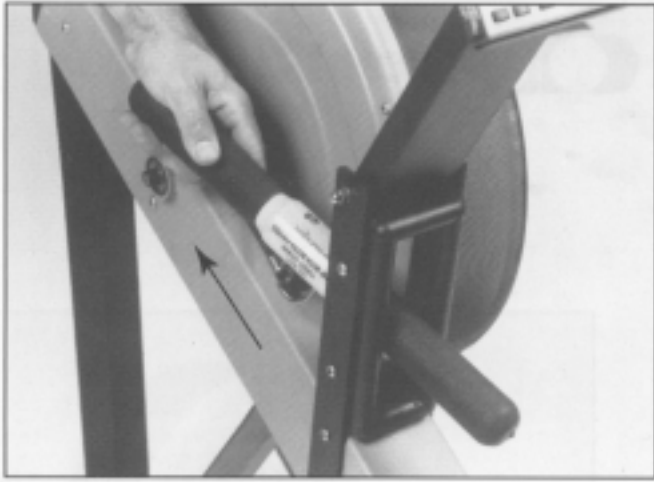

8.

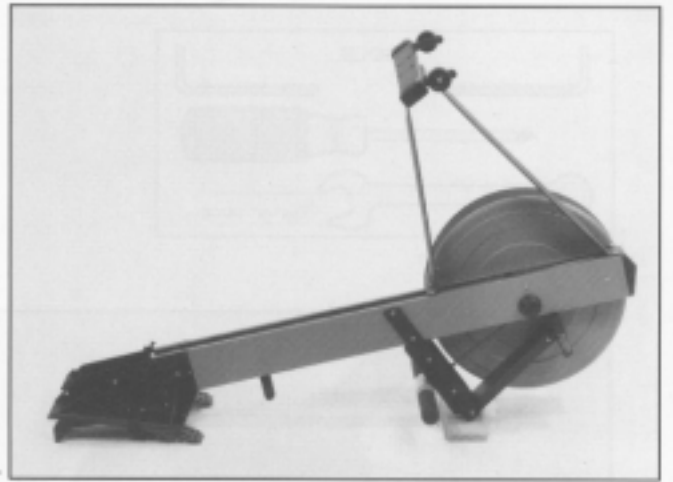

9.



10.

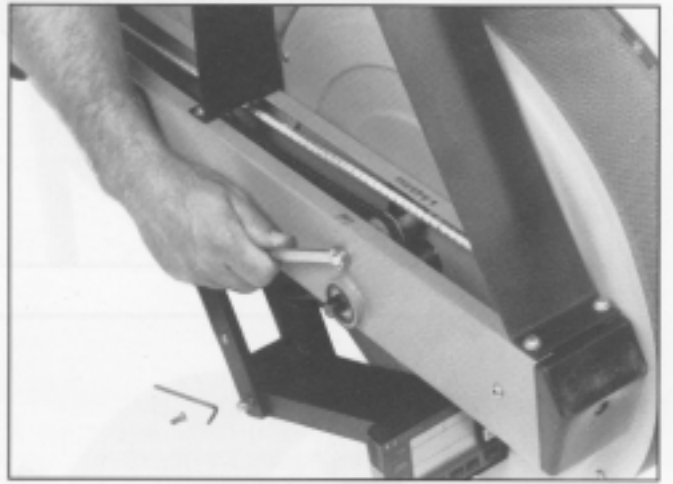

Insert unpatched bolt & turn

11.

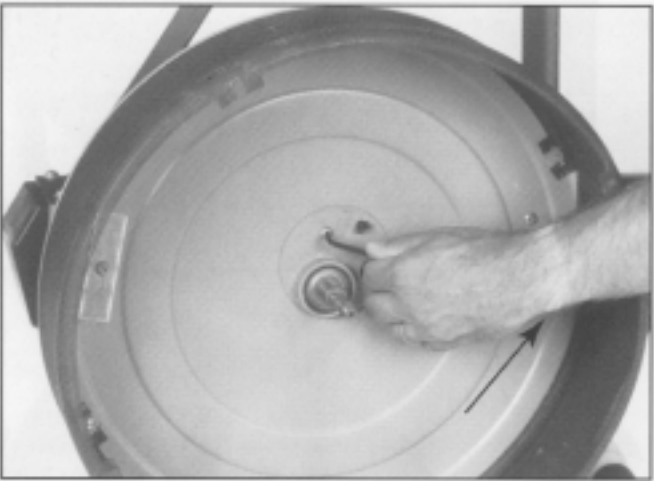

12.

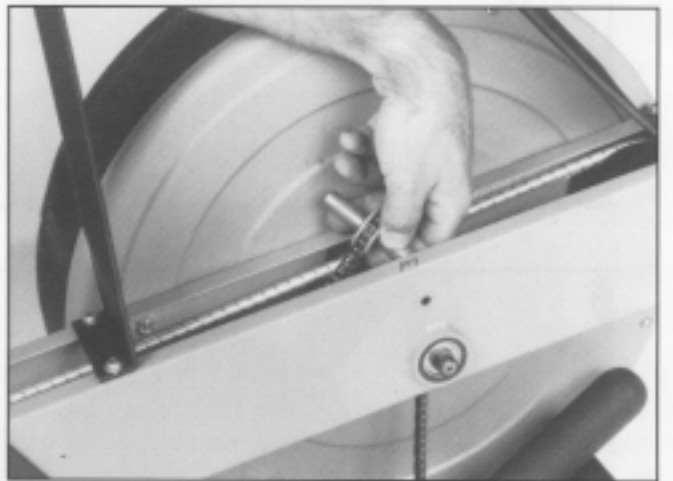

CHAIN IDLER PULLEY REPLACEMENT

Replace with Concept II PN 1717

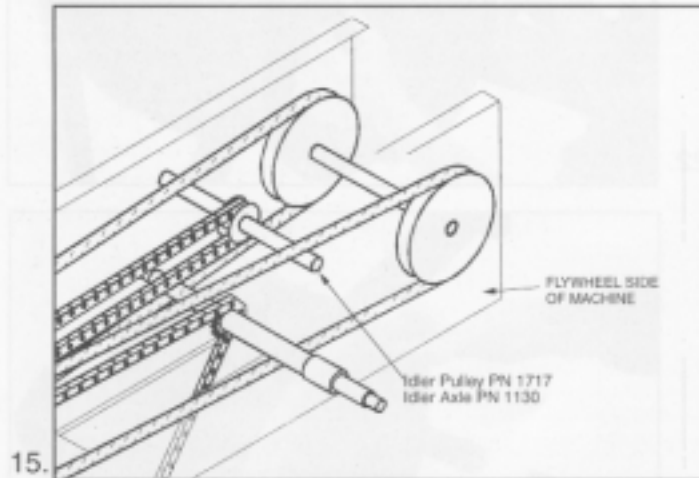
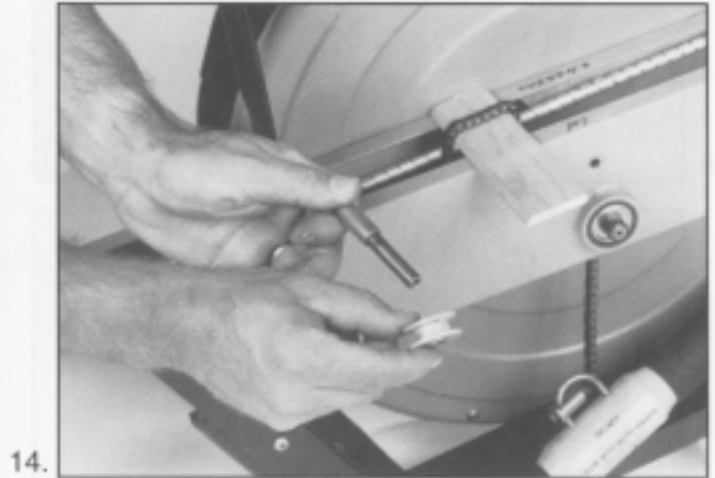

19.

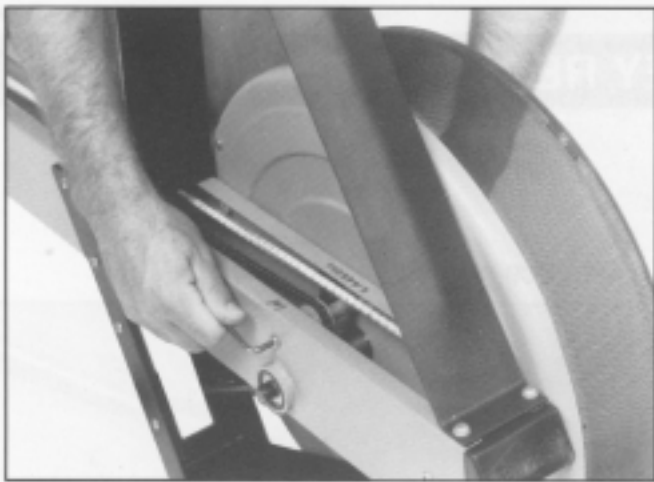

20.

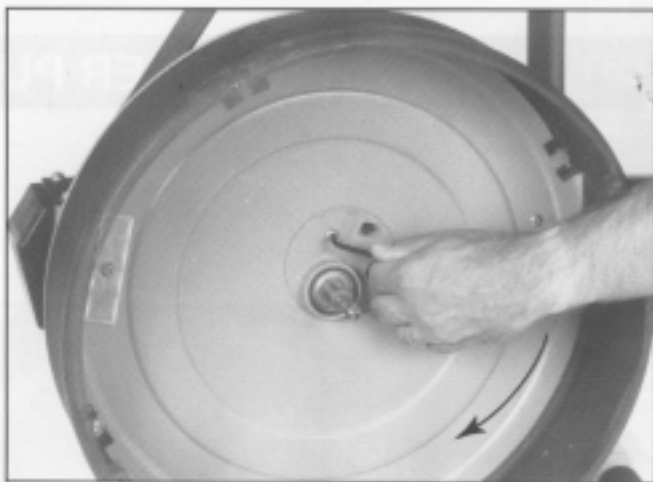

21.



22.

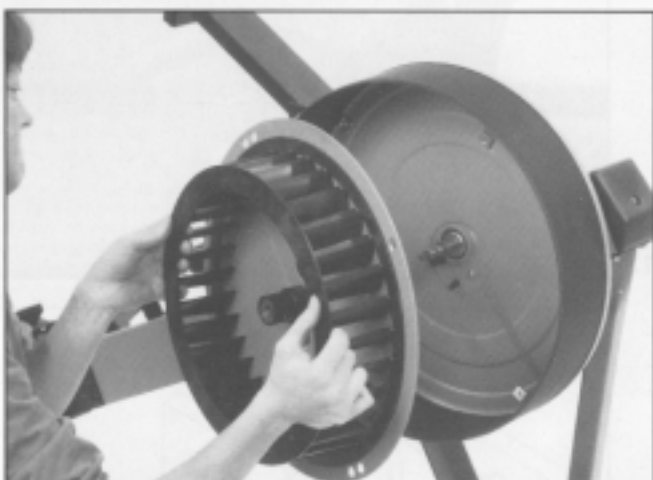

23.

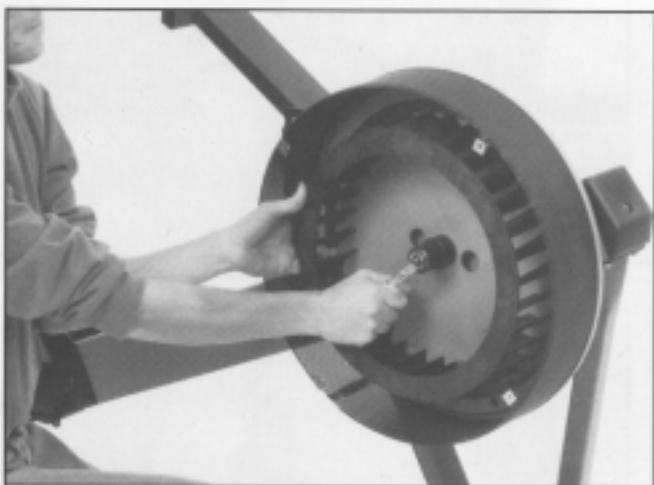

24.

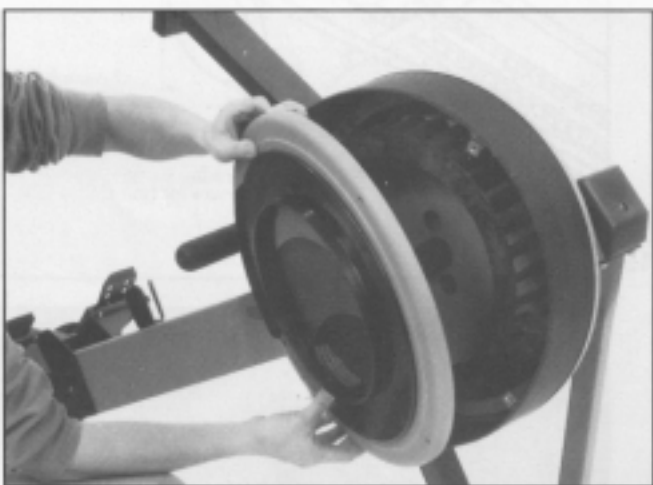

25.

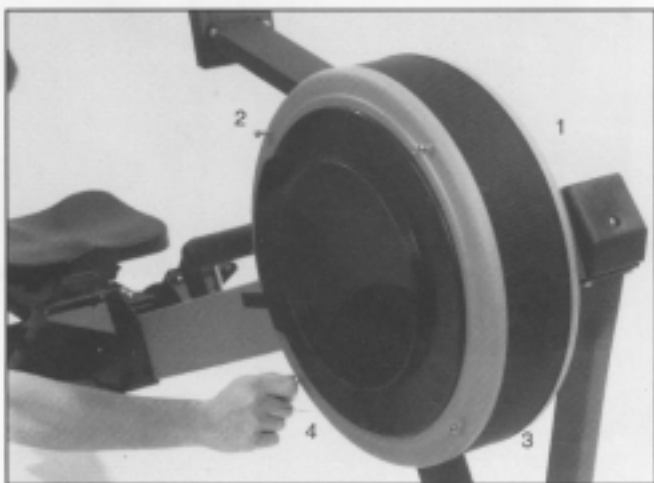

26.

