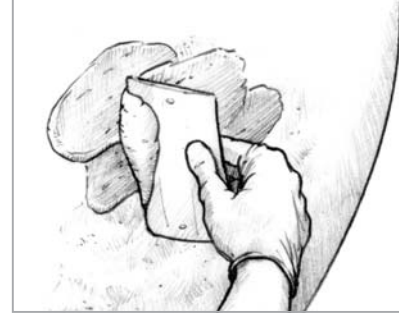
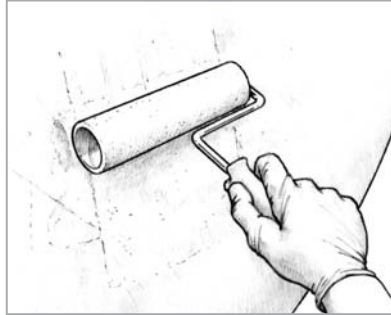
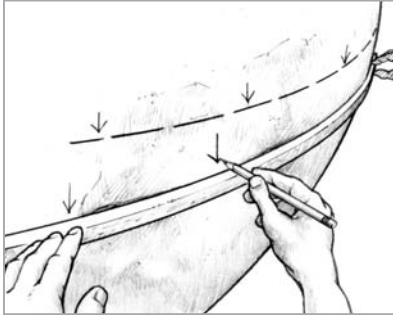


002-740

# Final Fairing & Finishing

Techniques for fairing surfaces with WEST SYSTEM® Brand epoxy and a guide to finish coatings



## Final Fairing

The first part of this manual describes final fairing techniques as they apply to boatbuilding and boat repair. These techniques are also useful for many non-marine applications such as auto body repair or building forms and molds. Also included are methods for applying fairing compound that can reduce trial and error, and help make the fairing process easier and faster.

## Finishing

The second part of this manual discusses epoxy as a barrier coating and the wide variety of finish coating options available for ultraviolet protection and long term durability. Cost, compatibility, durability, ease of application and health hazards are variables to consider in the selection of a coating option for your project.

**WEST  
SYSTEM**  
BRAND®

Catalog No. 002-740

# Final Fairing & Finishing

**Techniques for fairing surfaces with WEST SYSTEM® Brand epoxy  
and a guide to finish coating**

5th Edition—June 2005

The techniques described in this manual are based on the handling characteristics and physical properties of WEST SYSTEM Epoxy products. Because physical properties of resin systems and epoxy brands vary, using the techniques in this publication with coatings or adhesives other than WEST SYSTEM is not recommended. Refer to the current WEST SYSTEM User Manual & Product Guide for complete product information, and safety and handling guidelines.

The information presented herein is believed to be reliable as of publication date, but we cannot guarantee its accuracy in light of possible new discoveries. Because West System Inc. cannot control the use of WEST SYSTEM Brand products in customer possession, we do not make any warranty of merchantability or any warranty of fitness for a particular use or purpose. In no event, shall West System Inc. be liable for incidental or consequential damages.

WEST SYSTEM and Scarffer are registered trademarks, and Microlight and Episize are trademarks of West System Inc., Bay City, MI USA.

Copyright © February 1989, February 1994, September 1997, October 2001, June 2005 by West System Inc.

Published by West System Inc., Bay City, MI USA. All Rights reserved. No part of the contents of this book may be reproduced or transmitted in any form or by any means without the written permission of the publisher.

Printed in the USA

## About this manual

This manual is designed to be used along with the WEST SYSTEM® *User Manual and Product Guide*. If you do not have previous experience with epoxy, read and become familiar with the safety, handling and basic techniques presented in the WEST SYSTEM *User Manual and Product Guide*, available free from West System Inc. and Follow all safety precautions described in these manuals and on product labels. Structural repairs should be completed before beginning final fairing. For information on repairing fiberglass and wooden structures, refer to 002-550 *Fiberglass Boat Repair & Maintenance* or 002-970 *Wooden Boat Restoration & Repair*, published by West System Inc. If you have specific questions about the use of WEST SYSTEM brand epoxy, contact the West System Technical Staff:

West System Inc.  
P.O. Box 665  
Bay City, MI 48707 USA  
866-937-8797  
www.westsystem.com

## Table of Contents

Introduction . . . . .	1
<b>Final Fairing . . . . .</b>	<b>1</b>
Establishing a fair level . . . . .	2
Removing high areas . . . . .	3
Filling low areas . . . . .	4
Standard method . . . . .	5
Notched trowel method . . . . .	6
Guide methods . . . . .	7
Batten guide method . . . . .	8
Template guide method . . . . .	9
Template transfer . . . . .	12
Local fairing . . . . .	13
<b>Finishing. . . . .</b>	<b>13</b>
Epoxy barrier coating . . . . .	13
Recoating . . . . .	15
Final surface preparation . . . . .	16
Finish coatings . . . . .	16
Characteristics of coatings . . . . .	17
Coating types. . . . .	19
Final notes . . . . .	21
Appendix A Tools and materials . . . . .	22
Appendix B Lofting foil shapes for rudders and keels . . . . .	25
Appendix C Problem solving. . . . .	26
Appendix D Index . . . . .	29

## Introduction

No matter how well a boat is built, the builder's skill is often judged on the boat's outer fraction of an inch. When you see an undistorted reflection in a flawless paint job over a perfectly faired surface, you see a reflection of the builder's skill, attention to detail and pride in workmanship. Final fairing and finishing are more than the final steps in the boatbuilding process. They are two of the fine arts of boatbuilding.

The first part of this manual describes final fairing techniques as they apply to boatbuilding, and boat repair and restoration projects such as modifying a boat's shape and function, restoring or improving a hull's efficiency, or simply improving a boat's appearance. The value of these techniques is not limited to boatbuilding. WEST SYSTEM epoxy's versatility and ability to bond to many different materials permits these techniques to be used in a variety of non-marine applications as well, from auto body repair to building forms and molds.

These techniques are intended to reduce trial and error, and help make the final fairing process easier and faster by putting some science back into the art of fairing. However, achieving the perfectly faired surface still requires a critical attitude and a discriminating eye.

The second part of this manual discusses epoxy as a barrier coating and a base for the finish system. WEST SYSTEM epoxy is an excellent base for paints and clear finishes, but on surfaces exposed to sunlight it needs ultraviolet (UV) protection for long term durability. A wide variety of commercially available paints and clear finishes will protect epoxy surfaces from the effects of UV. Some may be more suited to your project than others. Cost, compatibility, durability, ease of application and health hazards are also variables to consider in the selection of a coating.

Because of the wide range of coating types, the variability of different brands, and the continuing advancement of coating technology, this section can only provide a general guide to the types of finishes. Coating terminology and product names can vary between manufactures, suppliers, and applicators, especially when referring to newer types of coatings. Read and follow manufacturers' recommendations and application instructions for specific coatings. If you are unsure of a product's compatibility or suitability, test the product on a representative sample before coating your project.

# Final Fairing

Fairing is the process of creating or shaping a smooth line, edge or surface, free of hollows or bumps. In traditional boatbuilding, fairing is first employed during the layout of the many individual lines of the boat on the lofting floor, or on the less traditional computer aided design (CAD) program. Each line is described by a series of plotted points. If one or more points is out of place, the line will not be true or accurate. If the line connecting these points does not flow smoothly or continuously, the line will not be "fair". Lines must be both true and fair. Plotting the points accurately requires careful measurement with a ruler, but the smoothness of a line flowing through those points is often best measured by eye. This is the conjunction of science and art in boatbuilding.

Properly lofted lines are then transferred to the profiles of the keel, bulkheads and frames. When assembled and properly aligned, their combined two-dimensional profiles describe the three-dimensional shape of the hull. If one or more of these components is out of place or unfair, the surface of the planking installed over them will not be fair.

## 2 Final Fairing

The skillful boatbuilder will keep the lines of the hull and deck surface both true and fair through all stages of construction, thereby reducing the amount of final fairing required. Up to a point, fairness is necessary to produce a hull that offers minimum resistance as it moves through the water. Beyond a certain point, the degree of fairness is a matter of personal pride and a reflection of the builder's craftsmanship.

Final fairing is the last step in the fairing process. Its purpose is to correct any unevenness or flaws in the surface after the structure is completed. Final fairing begins with overall fairing, that is removing major high spots and/or filling low spots over broad areas. Then local fairing removes any remaining minor surface irregularities and makes the surface texture smooth to the touch.

### Establishing a fair level

First consider the overall or general fairness of the surface, rather than individual or local high or low spots.

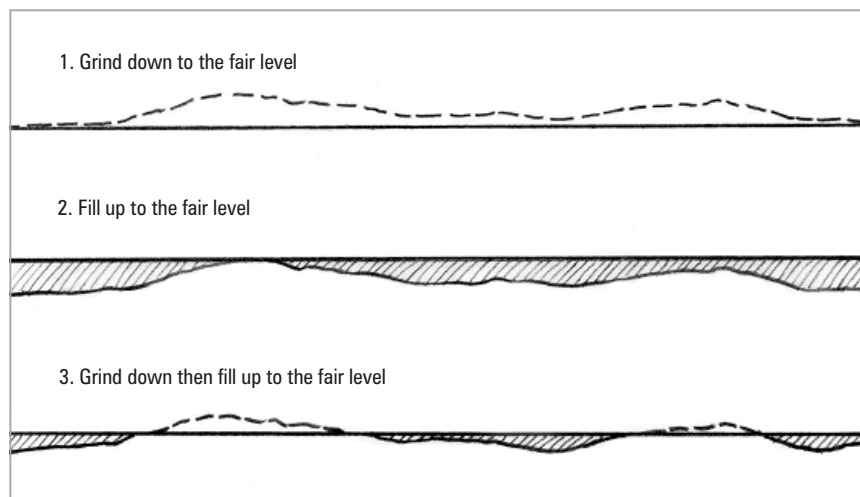
Imagine the earth without any water on it and you had the job of fairing it to a perfect sphere. You would have several options:

1. You could grind all of the land down to the lowest elevation (the bottom of the lowest ocean trench).
2. You could fill everything up to the highest elevation (the peak of Mt. Everest).
3. You could grind all of the land down to a specific level or elevation (sea level for example), and then fill the remaining low areas up to that level.

On a smaller scale, a fair surface on a boat hull is often achieved by removing material from highest areas until you reach a critical or convenient level or elevation, and then filling the remaining low areas up to that level (*Figure 1*).

The question of where to establish that level may be determined by the type and size of the boat, how accurately you want to maintain the hull's lines, the hardness or machinability of the surface material, the existing fairness and volume of material to be removed or added, skin thickness, whether the surface is to be finished clear or painted, the tools or equipment available, and your level of skill and endurance.

If you are fairing a wooden boat that you want to finish natural, such as a stripper canoe, you have little choice but to remove all of the high areas and establish the fair level at the lowest point on the surface, (option 1). This emphasizes the importance of keeping the hull fair throughout construction. If you are fairing a stripper canoe, for exam-



**Figure 1** Unfair surfaces can be 1. Ground down to the lowest level, 2. Filled to the highest level, 3. Ground to a specific elevation and filled to that level.

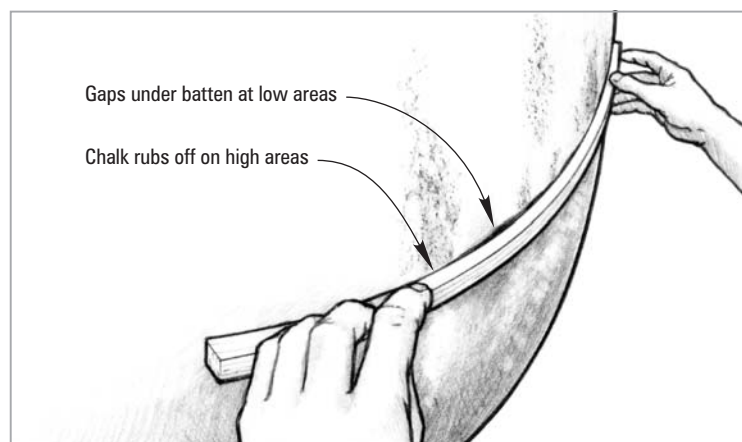
ple, and one of the frames is  $\frac{5}{16}$ " too high, you would have to alter the shape of the hull to avoid sanding a hole through  $\frac{1}{4}$ " planking.

If you are fairing a hard surface like a fiberglass, aluminum or steel hull, or a lead keel, removing a lot of material is impractical. You are pretty much limited to filling the low areas and establishing the level near or above the highest point on the surface, (option 2). Many steel and aluminum boats are built this way. A layer of fairing compound is applied over the completed hull and all of the fairing takes place in the easy-to-sand fairing compound outside of the hull's metal surface.

## Removing high areas

The first task in overall fairing is locating the high and low areas. Developing a good eye or feel for finding high or low areas may come naturally or with practice and trial and error. Whether you develop a good eye or not, a batten or chalk stick is an indispensable fairing tool. *See Appendix A, page 23.* A batten will also help you develop your eye by providing an accurate backup measurement to check against your eye and hand measurements.

As you hold the batten firmly against the surface, it will rest on the high spots and bridge the low areas. By moving the batten to different positions in an area, you should be able to get an idea of the surface topography.



**Figure 2** A batten will reveal the high and low areas, and the difference between them. Chalk applied to the batten will rub off on the high spots.

Mark the high spots by applying carpenter's chalk to the face of a batten, and rubbing the batten over the surface. The chalk will be deposited on the high spots (*Figure 2*). As you take the high spots down to fair, you can use the chalk stick as often as you like to monitor your progress. Continue removing high spots until you are satisfied with the fairness.

Methods for removing high spots depend on the material and how much of it needs to be removed. For aluminum, steel, fiberglass or other hard materials, a heavy duty disc sander may be the most practical tool to use. For rough fairing on wood or cured fairing compound, a plane, disc sander, belt sander or air file can be used, but some skill and experience are required to avoid sanding too deep. The short contact area of these tools also increases the risk of removing material from the wrong areas.

**Warning!** The dust generated from fairing can make it the dirtiest and one of the most hazardous operations in the boat shop. An appropriate dust mask and eye protection should *always* be worn. Wear appropriate protective clothing and keep your work area well ventilated. Refer to the safety information in the WEST SYSTEM *User Manual & Product Catalog* and on all product labels. Read and follow all power tool safety information.

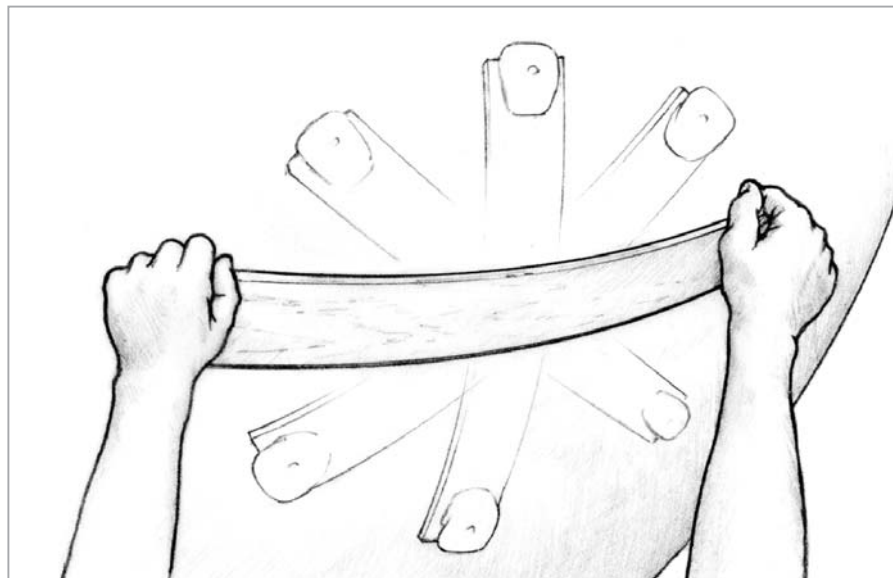
## 4 Final Fairing

A long flexible sanding block, or fairing board, is the primary tool for overall fairing on wood and fairing compound. *See Appendix A, page 23 for information on making fairing boards.* The key word is long, especially at early stages. Working on the same principle as the batten, the sanding board should bend to the overall shape of the surface, but be long enough and stiff enough to bridge the low areas and knock down the high spots over a large area. A short sanding block and most power tools at this stage will simply follow the contours and remove material from the low areas as well as the high areas.

We prefer aluminum oxide sandpaper as it seems to cut a wide range of materials, including cured epoxy/fairing material, better than other types of sandpaper. Zirconia alumina also cuts well and it wears longer. Stick sandpaper to boards and blocks with a feathering disc adhesive, or use adhesive backed sandpaper. Either will permit removal of the paper when replacement is needed. *See Appendix A, page 22 for more information about abrasives.*

Begin your final fairing with 50 or 60-grit paper, concentrating on taking down the high spots over a broad area. Change sanding direction frequently and check your progress from time to time by eye or feel, or with a batten.

When you are getting close to final fairness, switch to 80-grit paper. If you will be clear coating wood, begin to sand only in the direction of the grain to remove and avoid cross-grain scratches. Vary the angle you hold the board to avoid sanding in or creating a valley (*Figure 3*). As a final check, place the batten in different positions on the surface. The batten should make solid contact everywhere on the surface with no voids anywhere along its length.



**Figure 3** Vary the angle of the board ( $0^\circ, 45^\circ, 90^\circ$ ) to avoid sanding in or creating a valley.

### Filling low areas

If you will be painting the surface, you may decide that it is more practical at some point in the process to fill the remaining low areas with fairing compound rather than continue sanding high areas. Often the decision to begin filling low areas is determined simply by the volume of material remaining in the high areas and the time and effort required to remove it.

Four methods for filling low areas may be used depending on the area or volume to be filled and the degree of fairness and accuracy required. A large job may have applications for all of these methods.

The **standard method** relies on your eye or a batten to judge the application and removal of the fairing compound. It is the method most often used, but requires some experience and/or a good eye to fair very large areas efficiently.

The **notched trowel method** is a variation of the standard method that makes it easier to sand larger areas. It also relies on your eye to judge the application of the fairing compound.

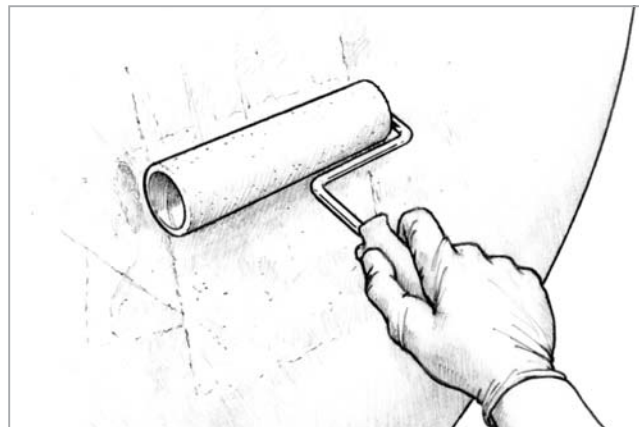
The **batten guide method** involves more steps than the standard or notched methods, but offers a more efficient application of the fairing compound.

The **template guide method**, similar to the batten guide method, is useful when the surface must describe a specific shape very accurately. It is often used to produce accurately faired keel and rudder foils.

## Standard method

This method requires you to judge the application of the fairing compound visually and with the aid of a batten. You may need to repeat the process several times to reach a fair surface; however, you should become more efficient with practice.

1. Be sure surfaces to be coated are clean, dry and sanded. Clean contaminated fiberglass or metal surfaces with solvent *before* sanding. Sand or grind metal surfaces with a coarse grit to remove oxidation and provide a texture for the epoxy to key into. Before coating, identify the low areas by feel or with a batten and estimate the volume of filler required to slightly overfill the void.
2. Wet out the surface with resin/hardener mixture (*Figure 4*). It is a good idea to coat the entire surface or repair area at this time. When coating metal surfaces, you can increase the ultimate adhesion of the fairing material by sanding the wet epoxy mixture into the metal with coarse sandpaper. To avoid sagging, allow the wet-out coat to gel before applying the fairing compound. Sanded epoxy surfaces do not need to be wet out.

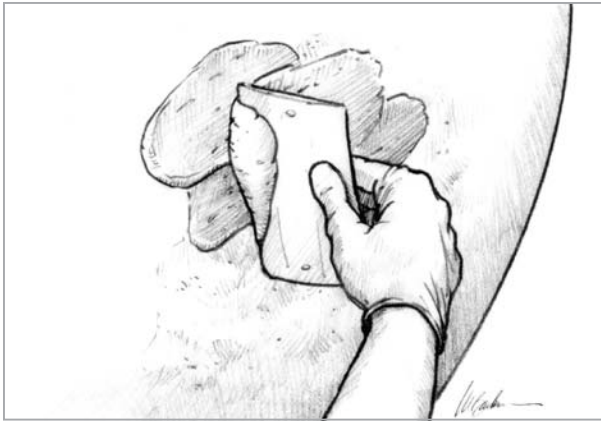


**Figure 4** Wet out the surface with resin/hardener mixture. To avoid sags, allow the wet-out coat to gel before applying fairing compound.

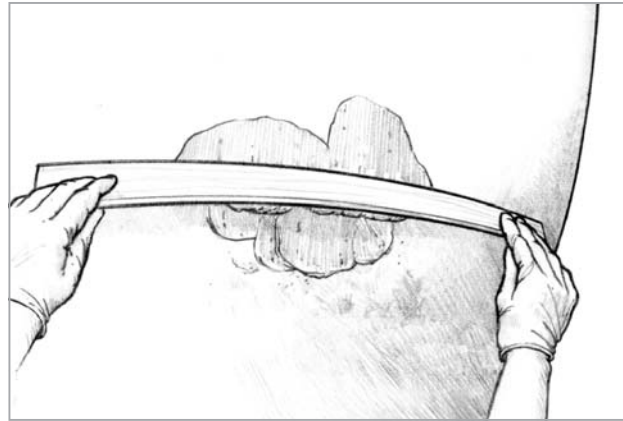
3. Prepare a fairing compound with epoxy and either 407 Low-Density or 410 Microlight™ filler. Dispense no more than 1/4 of a pot full of resin/ hardener to allow room for filler. Mix the resin/ hardener together thoroughly. Stir in filler until it reaches a non-sagging, peanut butter consistency.
4. Trowel the mixture on with a plastic spreader. Fill the low areas to just above the fair level so the fairing compound can be sanded back down to fair without having to be re-filled. Use the spreader to smooth the compound as close as possible to the desired shape to avoid excessive sanding after the mixture has cured (*Figure 5*). The contour of



## 6 Final Fairing



**Figure 5** Use a spreader to apply fairing compound, and slightly overfill the area. Shape the mixture to blend with the surrounding contour.



**Figure 6** On large areas, use a batten to shape the compound after applying it with a spreader.

small areas can often be judged by eye. When filling voids over 1/2" deep, it's best to apply the mixture in two or more layers to avoid excessive heat build up from the exothermic curing reaction. Apply the second layer after the first layer has partially cured.

5. Use a batten to help shape larger areas. After slightly overfilling the area with a spreader, slowly drag a batten across the filled area while bending it to the contour of the surrounding fair areas (*Figure 6*). A slight "Z" or back and forth motion of the batten can help to reduce the drag of the fairing compound. Allow the fairing compound to cure thoroughly before sanding.
6. With the application of the fairing compound, low areas have now become high areas. Sand these areas down to fair using the techniques for overall fairing. Continue to check for fairness as you sand.
7. Fill and sand any low areas you find as many times as necessary until you are satisfied with the overall fairness. When refilling areas, it is not necessary to re-coat the surface with unthickened epoxy unless you've sanded through the first coating into the original surface.

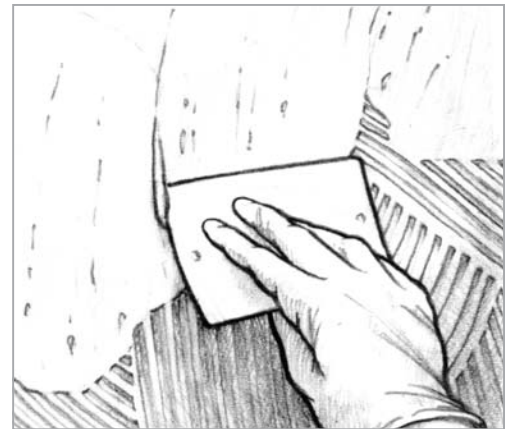
### Notched trowel method

When fairing large areas that require a lot of filling, such as a steel or aluminum hull, it may be easier and more economical to divide the process into two stages. The notched trowel method helps to eliminate much of the sanding time required during the early part of the fairing process by reducing the volume of fairing compound to be sanded. The first layer of fairing compound is applied with a notched spreader to leave a pattern of ridges. Before starting the procedure, use a batten to determine the depths of the areas to be filled and cut the length of the notches in the spreader to match the deepest area.

1. Be sure surfaces to be coated are clean, dry and sanded. Clean contaminated fiberglass or metal surfaces with solvent *before* sanding. Sand or grind metal surfaces with a coarse grit to remove oxidation and provide a texture for the epoxy to key into.
2. Wet out the surface with resin/hardener mixture (*Figure 4*). Coat the entire surface or repair area at this time. To avoid sagging, allow the wet-out coat to gel before applying the fairing compound. Sanded epoxy surfaces do not need to be wet out.
3. Prepare a fairing compound with epoxy and either 407 Low-Density or 410 Microlight™ filler. Dispense no more than 1/4 of a pot full of resin/hardener to allow room for filler. Mix the resin/hardener together thoroughly. Stir in filler until it reaches a stiff, peanut butter consistency.



**Figure 7** Apply the fairing compound with the notched spreader. Control the height of the ridges by the angle you hold the spreader.



**Figure 8** Trowel a second layer of fairing compound over the surface to fill the grooves after the ridges have been sanded fair.

4. Apply the fairing compound with the notched spreader (*Figure 7*). Hold the spreader at a higher angle to leave deeper ridges on the lowest areas and at a lower angle to leave shallower ridges on the higher areas. The tops of the ridges should be slightly above the finished fair level. Allow the fairing compound to cure thoroughly.
5. Sand the ridges fair. The ridges of fairing compound are much easier to sand than solid material.
6. Prepare the surface for bonding. Use a wire brush to rough up the exposed surface of the fairing compound within the grooves.
7. Trowel a second layer of fairing compound over the surface to fill the grooves (*Figure 8*). Use a smooth-edged spreader held firmly against the surface. spreader away excess compound, leaving a smooth surface flush with the faired ridges. Mix the fairing compound for the second layer to the same density as the first layer. Allow the fairing compound to cure thoroughly.
8. Sand the surface smooth. It should require only minor local fairing before barrier coating and finishing as described in the Finishing section.

## Guide methods

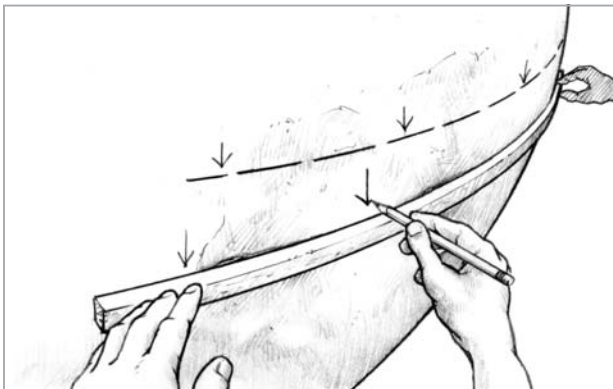
The standard method for filling low areas is often one of trial and error. Excess fairing material is applied, then removed and often reapplied and removed until a fair level is reached. Skill and experience are required to accurately apply the fairing compound and cut it away to produce a fair surface with a minimum of waste and effort. The **batten guide** or **template guide** methods allow you to accurately fill low areas over a very large area, even entire hulls, using a minimum of material and requiring less sanding time.

Ridges of fairing compound are applied across the unfair surface and a batten or templates are pressed into the ridges. When cured, the cast batten or template profiles provide guides for the application of the remaining fairing compound. A batten laid across the guides accurately controls the level of the fairing compound applied between the guides, in much the same way concrete is leveled between two forms to build a sidewalk. The number of guides required depends on the size and shape of the surface. On flat or simple curved areas like a hard chined hull or a fin keel, one to three guides may be enough to describe the surface. On curved surfaces, a number of closely spaced guides may be necessary to accurately describe surface. A single guide may be placed in an unfair area for general reference or many may be applied over an entire hull in a regular grid pattern for more precise application.

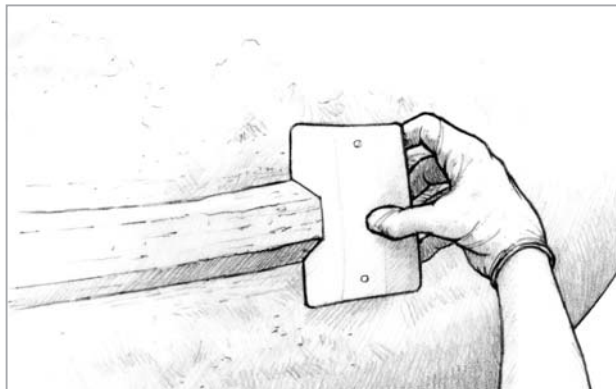
## Batten guide method

The batten guide method uses a flexible batten to cast an impression in the ridge of fairing compound. The resulting profile is determined by the stiffness of the batten and the batten's points of contact with the unfair surface. The batten should be a suitable stiffness for the curve of the fairing area. This procedure may require at least two people to support and accurately position the batten.

1. Prepare the area for bonding. Remove all paint. Wire brush the entire surface of external keels to remove any contamination and to expose fresh iron or lead. Sand the surface of internal keels or hulls to remove loose fillers and gelcoat and expose solid fiberglass laminate. Dry the surface if necessary, using a hot air gun, hair dryer or heat lamp.
2. Determine and mark the locations for the guides. If you are fairing a curved surface like a hull, you may need to provide at least three parallel profile guides to describe the curve. Smaller radiused curves and complex shapes may require more or closer spaced guides. Use a long batten to locate the high spots and determine how much fairing compound will be required to fill the low areas to a level above the bottom of the batten. Mark the high spots where the batten touches the surface (*Figure 9*).
3. Wet out a 2"–3" wide strip at each guide location. If you are working with a lead or metal keel, wire brush the surface while the epoxy is still wet for a better bond. Allow the epoxy to gel.

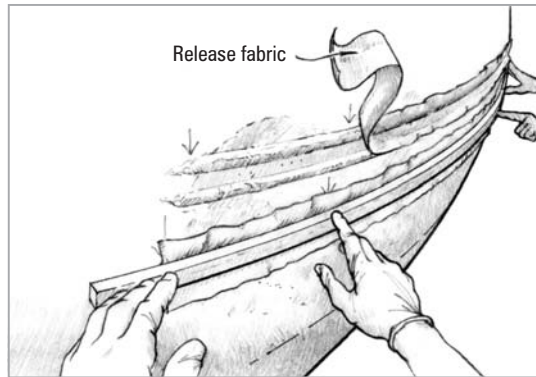


**Figure 9** Use a long batten to locate the high and low areas and judge the amount of fairing compound required.

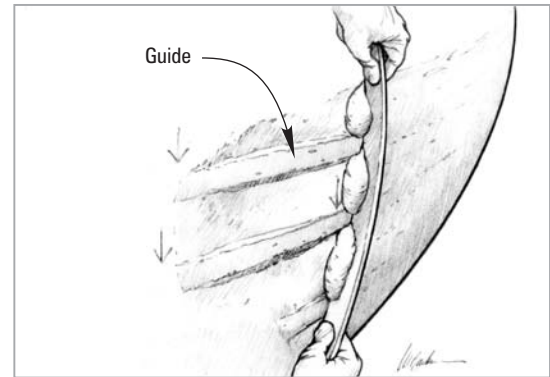


**Figure 10** Use a spreader notched to the shape of the ridge to shape the mixture.

4. Apply a 1"–2" wide ridge of fairing compound to the surface at each guide location. Use the same mixture of epoxy/407 or 410 filler, thickened to a stiff, peanut butter consistency, that will be used to fill between the guides. Trowel on the fairing mixture with a plastic spreader, and then use a spreader notched to the shape of the ridge to shape the mixture (*Figure 10*). Cut the notch deep enough to equal the height of the ridge at the lowest area of the surface. Tilt the spreader as necessary to adjust the height.
5. Cover the ridges with strips of 879 Release Fabric. Press the fabric lightly to the surface. Do not press hard enough to flatten the ridges. Tape the fabric in place if necessary.
6. Press the batten into the ridge of thickened epoxy until it contacts the high spots in the surface. Push the batten into the ridge. Apply pressure only where the batten touched the high spot you marked earlier (*Figure 11*). If an area of the epoxy ridge is too low to contact the batten, squeeze the sides of the epoxy ridge together under the fabric so that it is forced up to contact the batten. When you're satisfied, carefully remove the batten without disturbing the ridge or the fabric. Repeat the process for each batten guide and allow the epoxy mixture to cure thoroughly.



**Figure 11** Push the batten into the ridge. Apply pressure only where the batten touched the high spot you marked earlier.



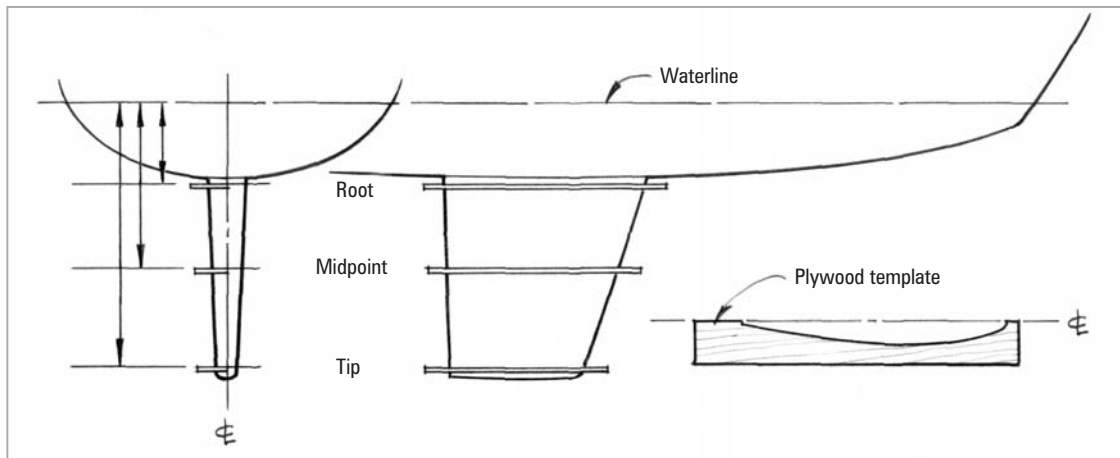
**Figure 12** Drag the batten along the guides, removing excess mixture and leaving the surface between the guides smooth and level with the

7. Remove the release fabric strips and mark the center of the batten impression with a permanent felt marker to act as a sanding indicator. Sand the ridges on either side of the batten impression flush with the center. Avoid sanding into the profile. You should be left with smooth bands of fairing compound that will be used as guides to accurately apply the remaining fairing material.
8. Wet out the surface between the guides with epoxy. Allow the coating to gel.
9. Apply a layer of the epoxy/407 or 410 filler to the surfaces between the profile guides. Use the same filler and filler consistency that was used to make the guides. Use a plastic spreader to apply and smooth the mixture slightly higher than the guides.
10. Shape the fairing mixture before it begins to gel, using an appropriate batten. With the batten held perpendicular to and pressed to the guides, drag it along the guides. The batten will follow the guide profiles, removing excess mixture and leaving the surface between the guides smooth and level with the guides (*Figure 12*). To give yourself adequate working time in warmer temperatures, use 206 or 209 Hardener or fill just one section at a time. Allow the fairing mixture to cure thoroughly.
11. Sand the cured surface fair, being careful not to sand through the indicator you marked on the top of the guide. Use battens to check for fairness in both directions. Fill any remaining low areas again when cured. Repeat as necessary until you are satisfied with the shape and fairness of the surface.
12. Repeat the process on all areas to be faired. When you are satisfied with the fairness and smoothness, apply epoxy barrier coats and finish as described in the Finishing section.

A variation of the previous method is to apply fairing compound to a large area. Lay strips of release fabric on the surface in several locations, and then press a batten to the surface at each location before the mixture begins to gel. If a thick enough layer of fairing compound is applied, the batten will leave a fair profile indentation in the fresh mixture. When the mixture cures, remove the strips and use the batten profiles as sanding guides. This method reduces the number of steps in the procedure, but requires more sanding.

### Template guide method

This method is similar to the batten guide method except that a template describing a specific profile is used to shape the guide rather than a batten. Although a batten-generated profile may be fair, the high points of the unfair surface will determine the profile. Template profiles may be lofted from offsets (*See Appendix B*) or transferred from an existing surface (*See Template Transfer following this section*).



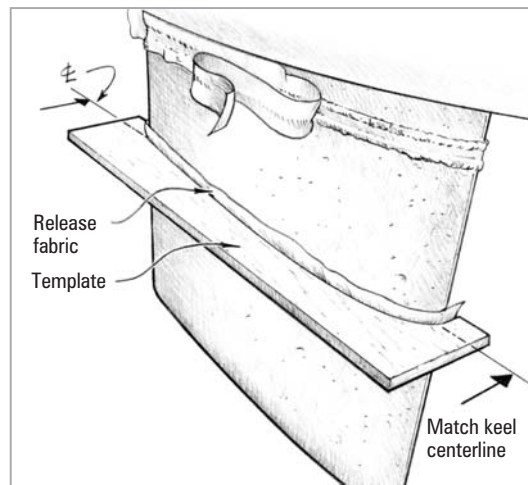
**Figure 13** Obtain the profiles for three locations on the keel: the root (top of the keel near the hull attachment point), the midpoint and the tip of the keel.

One of the best uses of this method is to improve the efficiency of rudders and centerboards. The following example describes the use of templates to establish precise foil shaped guides on the surface of a keel and the application of fairing compound between the guides. Although the procedure describes keel templating, the same procedure applies to rudders or any other lofted shape. This procedure may require at least two people to support and accurately position the templates.

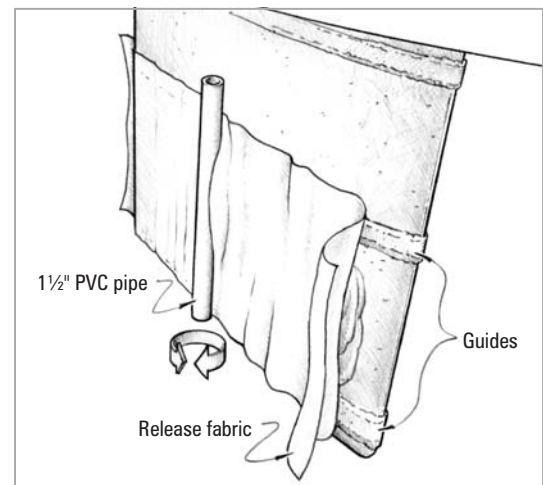
1. Transfer the full size profiles to  $\frac{1}{2}$ " A/C-grade plywood (Figure 13). Cut out the three templates with a band saw or saber saw and sand the edges of the foil shape carefully to eliminate any bumps or unfairness. Mark the keel's centerline on each end of the template. Seal the profile edge of the templates with a coat of epoxy and sand them smooth after the epoxy cures.
2. Prepare the area for bonding. Remove all paint. Wire brush the entire surface of external keels to remove any contamination and to expose fresh iron or lead. (Be sure to wear an appropriate dust mask, especially when sanding or wire brushing lead.) Sand the surface of internal keels (or hulls) to remove loose fillers and gelcoat and expose solid fiberglass laminate. Dry the keel using a hot air gun, hair dryer or heat lamp. Locate and mark the centerline on the leading edge and, if necessary, the trailing edge of the keel. Mark the template locations on both sides of the keel. Check the keel's profile with the templates to locate any high spots and to gauge how much fairing compound to apply to the low areas. Grind down or plane off excessive high spots.
3. Wet out 2"–3" wide strips at the template locations with epoxy. If you are working with a lead or metal keel, wire brush the surface while the epoxy is still wet for a better bond. Allow the epoxy to gel.
4. Apply a 1"–2" wide ridge of epoxy/407 or 410 filler mixture (thickened to a stiff, peanut butter consistency) to the surface at each template location. Use a plastic spreader to trowel on the fairing mixture slightly thicker than the finished profile. A spreader notched to the shape of the ridge is helpful to shape the mixture.
5. Cover the ridges with a strips of 879 Release Fabric to keep the fairing mixture from sticking to the template. Lightly press the release fabric to the ridge. Do not press hard enough to flatten the ridge.
6. Push the templates into the soft mixture to make an impression of the exact keel profile at each template location. To gauge the depth of the impression (height of the profile), push the template into the mixture until the centerlines marked on the template match the centerlines marked on the leading and trailing edges of the keel (Figure 14). If an area of the ridge is too low to contact the template when it is properly aligned, squeeze

the material under the release fabric upward so it comes in contact with the template. When you're satisfied, carefully remove the template, leave the release fabric in place, and allow the mixture to cure thoroughly.

7. Remove the release fabric and mark the center of the template impression with a permanent felt marker to act as a sanding guide. Sand the ridges on either side of the template impression flush with the profile. Avoid sanding into the profile. You should be left with smooth bands of fairing compound at the root, midpoint and tip of the keel that will be used as profile guides to accurately apply the remaining fairing material. Use the templates to check the profiles and sand or add filler to the profile as necessary to match the template.
8. Wet out the surface between the guides with epoxy. Allow the coating to gel.
9. Mix enough epoxy/407 or 410 fairing compound to fill the area between two of the profile guides. Use the same filler and filler consistency used to make the guides. With a plastic spreader or custom spreader, apply the mixture to the middle area of the foil. Leave the mixture higher than the guides. See *Appendix A for information on mixing and applying large quantities of fairing compound.*



**Figure 14** Push the template into the mixture until the centerlines marked on the template match the centerlines marked on the leading and trailing edges of the keel



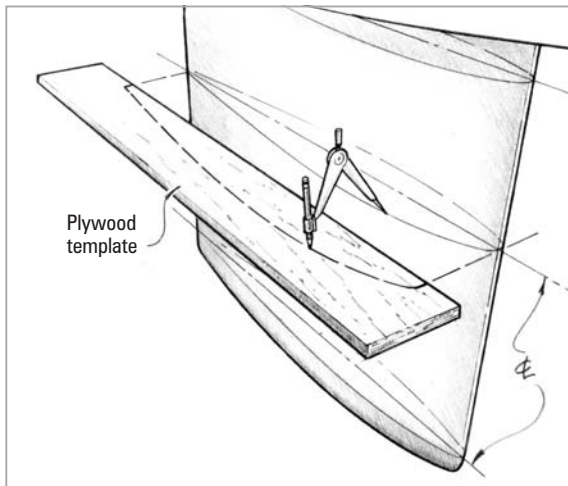
**Figure 15** Using a length of 1/2" diameter PVC pipe, shape the fairing mixture flush with the guides by rolling the pipe back and forth on the guides, as you would a rolling pin.

10. Lay a precut piece of release fabric over the fairing compound. The fabric should be large enough to cover the entire area from guide to guide. Using a length of 1/2" diameter PVC pipe cut to span two of the guides, shape the fairing mixture flush with the guides. Beginning in the middle of the foil, roll the pipe back and forth, as you would a rolling pin, forcing fairing compound under the release fabric toward the leading and trailing edges of the foil (*Figure 15*). Adjust the angle of the pipe as you approach the edges of the foil to finish with the pipe parallel to the leading and trailing edges. With the proper amount of fairing compound, a small amount of excess will squeeze from the leading and trailing edge. To give yourself adequate working time in warmer temperatures, use 206 or 209 Hardener. Allow the fairing mixture to cure thoroughly.
11. Remove the release fabric. Repeat the process on the remaining areas. Fill any large remaining low areas using the same procedure after the fairing compound has cured. Repeat as necessary until you are satisfied with the shape and fairness of the surface.
12. Sand the cured surface as necessary. It should require only minor local fairing. When you are satisfied with the fairness and smoothness, apply an epoxy barrier coat and finish as described in the Finishing section.

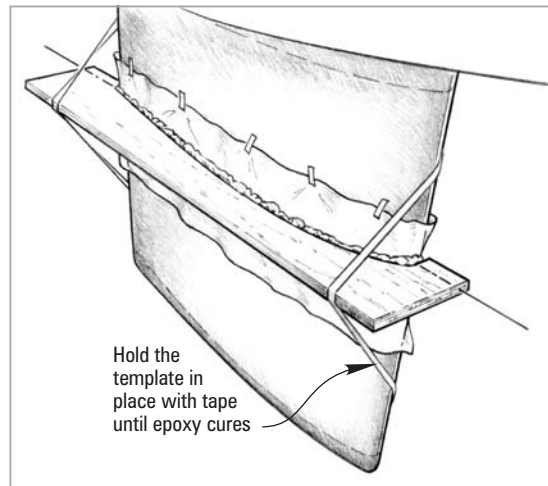
## Template transfer

Template transfer is a method of casting a template profile of an existing shape, using its surface as a mold. The technique has a variety of uses. In the keel fairing situation above, the transfer method can be used to transfer the shape of one side of an existing keel to the opposite side to make the keel symmetrical or it can be used to transfer the shape of one keel or hull to another. The technique can also be used to cast an accurate hull profile to build bunks for cradles or trailers, or any similar situation that requires a shape to be accurately duplicated. The following procedure describes the transfer of a keel foil shape. For accuracy, templates should be transferred in at least two or three locations on the keel.

1. Determine the template transfer locations on the keel. To prevent the template from bonding to the keel, tape a strip of plastic over the area to be cast. (A smooth surface may be waxed to prevent bonding. Apply several coats of paste wax to act as a mold release. Be sure the surface has no recesses that would allow the epoxy to “key” into the surface.)
2. Prepare a rough plywood template scribed to within  $\frac{1}{4}$ " of the profile you wish to transfer (*Figure 16*). Cut the template from  $\frac{3}{8}$ " or  $\frac{1}{2}$ " plywood or particle board several inches longer than the foil. Prepare a method to clamp or brace the template in position against the surface.



**Figure 16** Prepare a rough plywood template scribed to within  $\frac{1}{4}$ " of the profile you wish to transfer.



**Figure 17** Press the template in place against the surface until the thickened mixture makes contact with the surface everywhere along the profile.

3. Wet out the profile edge of the plywood (the edge facing the surface) with epoxy. Apply a bead of epoxy/406 or 404 mixture (thickened to a stiff, peanut butter consistency) to the profile edge of the plywood. The bead should be high enough to bridge any gaps between the template and the foil.
4. Press the template in place against the surface until the thickened mixture makes contact with the surface everywhere along the profile (*Figure 17*). Use duct tape or masking tape to brace the template in position. Fill in any gaps or displaced mixture and allow the mixture to cure thoroughly.
5. Carefully mark the leading and trailing edge centerlines on the template. Remove the clamps or braces. Remove the template from the surface. Sand the ridges that squeezed from the edge to make both faces of the plywood smooth. Repeat the procedure in the other transfer locations.

## Local fairing

When the difference between high and low areas is reduced by overall fairing (either by sanding down or filling up) or if your hull is generally fair to begin with, you can begin to concentrate on local fairing. Local fairing may be done with smaller sanding blocks, an orbital sander or an air file, using 80 grit sandpaper. It is not necessary to use sandpaper finer than 80 grit. Finer sanding will be done after the final coating. The object is to remove minor bumps or flaws and leave a smooth even texture over the entire surface. A shorter batten may be useful at the early stages of local fairing, but as you continue to eliminate the minor bumps, the batten should become less and less useful.

This is the stage where you rely most on your eye to tell you what is fair. A light held close to the surface will cast long shadows that can help you detect slight surface variations. A clear bulb will cast sharper, more detailed shadows than a frosted or fluorescent bulb. Moving the light around to cast shadows from different directions will help you to locate bumps and voids and determine their height or depth. Fill voids with a thin layer of fairing compound if necessary. Rub your hand lightly over the surface in different directions to detect minor flaws that may not be apparent to your eye. As the surface becomes smoother, your fingertips may be the final judge of fairness. How far you continue with local fairing depends on your ability to detect flaws and how critical you are. Keep in mind that flaws that seem insignificant in a dull 80 grit finish will be more noticeable in a glossy finish, especially a dark colored glossy finish.

After the fairing is completed, fiberglass fabric can be applied to the surface if desired. Fabric is often used to reinforce the structure and/or to provide abrasion resistance to the surface. *Refer to the current WEST SYSTEM User Manual & Product Catalog for details on applying fiberglass cloth.*

**Note!** An epoxy barrier coat is *required* over sanded 410 Filler, if you are going to apply a solvented coating over the faired surface. Solvents in these coatings can affect 410 Filler and result in print through. An epoxy barrier coat is *recommended* over sanded 407 Filler to provide a consistent non-porous surface for finish coatings.

# Finishing

Applying an epoxy barrier coating is the last step in the fairing process and the first step in the finishing process. It is included in the Finishing section because an epoxy barrier coating is widely used as an interface between substrates and paints and varnishes even when fairing is not required. Epoxy bonds to a wide range of materials better than most finish coatings, it is compatible with a wide range of finish coatings, and the stability of an epoxy base helps finishes to last longer than they would over the substrate alone. The combination of an epoxy barrier coating topped with a durable finish coating provides a very effective finish system.

## Epoxy barrier coating

The object of epoxy barrier coating is to build up an epoxy layer that protects the substrate from moisture. In doing so it stabilizes the substrate and provides a smooth stable base for the finish coating needed for UV protection.

For an effective moisture barrier on most exterior surfaces, apply a minimum of three coats (about 10 mils) of WEST SYSTEM epoxy. Moisture protection will increase with additional coats, up to six coats or about a 20 mil thickness. A minimum of six coats is recommended on fiberglass hulls below the waterline.

For best results, apply the coatings at or above room temperature. Epoxy will be thinner and spread more easily in warmer temperatures. Adding solvents to thin WEST



SYSTEM epoxy compromises its strength and moisture resistance, and is not recommended. Additives or pigments should not be added to the first coat.

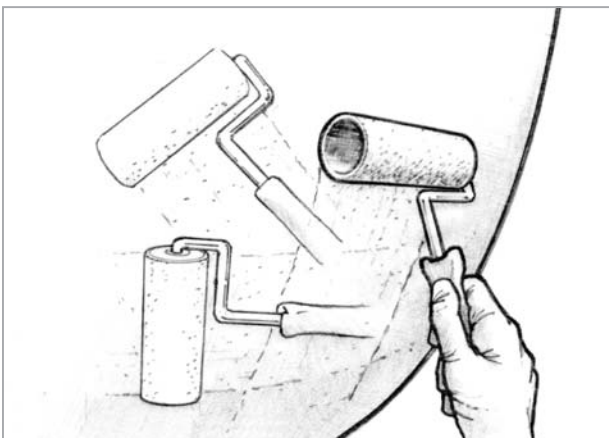
Disposable, thin urethane foam rollers, such as WEST SYSTEM 800 Roller Covers, are essential for applying epoxy. They allow you greater control over film thickness, leave less stipple than thicker nap-type roller covers, and the epoxy does not build up and cure as quickly on the cover. When used with an 801 Roller Frame, the covers may be cut into narrower widths to reach difficult areas or for coating long narrow surfaces like stringers.

Complete all fairing and cloth application before beginning the final coating. Allow the temperature of porous surfaces to stabilize before coating. Otherwise, as the material warms up, air within the porous material may expand and pass from the material through the coating (out-gassing) and leave bubbles in the cured coating. For most situations that will be coated with an opaque finish, 105 Resin with 205 or 206 Hardener are recommended. When extra working time is needed in warmer temperatures, use 105 Resin with 209 Extra Slow Hardener. For clear finishes over wood, use 207 Special Coating Hardener.

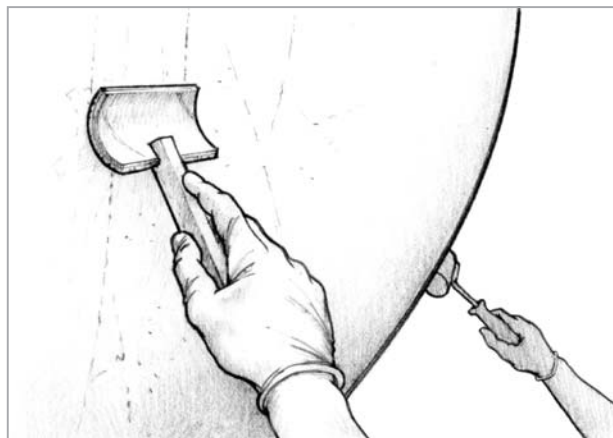
While coating, remember that the thinner the film thickness, the easier it is to control the evenness of the film and avoid runs or sags in each coat. Thin coats also reduce the risk of trapped air bubbles in the coating. Fewer thick coats may take less time to apply, but will require more sanding and possibly more time overall.

Apply an epoxy barrier coat as follows:

1. Prepare the surface as necessary. After local fairing, the surface should be immediately ready for bonding. To avoid the possibility of surface contamination, begin the coating operation within 24 hours of final sanding.
2. Mix only as much resin/hardener as you can apply during the open time of the mixture. Pour the mixture into a roller pan as soon as it is mixed thoroughly.
3. Load the roller with a moderate amount of the epoxy mixture. Roll the excess out on the ramp part of the roller pan to get a uniform coating on the roller.
4. Transfer the epoxy evenly to a small area. Roll lightly and randomly over an area approximately 2' x 2' (Figure 18).
5. Work the epoxy from thicker areas into thinner areas to spread it into a thin even film. Increase pressure slightly as the roller dries out. Expand the coverage area if necessary to thin out the film. Avoid working air into the coating by rolling too vigorously.
6. Finish the area with long, light, even strokes to reduce roller marks. Overlap the previously coated area to blend both areas together.



**Figure 18** Using a foam roller, apply the epoxy and spread it into a thin even film.



**Figure 19** Tip off each batch, as soon as it is applied, by dragging a roller cover brush lightly over the wet surface.

7. Coat as many of these small working areas as you can with each batch. If a batch begins to thicken before it can be applied, discard it and mix a fresh, smaller batch.
8. Tip off each batch, as soon as it is applied, by dragging a roller cover brush lightly over the coating in continuous, parallel, overlapping strokes. Press hard enough to smooth the stipple and remove air bubbles, but not hard enough to remove any of the coating (*Figure 19*). Overlap and blend in the edge of the previous batch. The proper film thickness will flow out smooth and level, even on vertical surfaces. *See Appendix A or the 800 Roller Cover package for information on making a roller cover brush.*

## Recoating

Apply second and subsequent coats of epoxy following the same procedures. Make sure the previous coat has cured firmly enough to support the weight of the next coat. The ideal time to recoat is when you can still leave a finger print in the previous coat, but it will no longer come off on your finger. Epoxy will chemically bond to a previous coat of epoxy that has not fully cured. Fully cured epoxy must be prepared by washing (see amine blush below) and sanding to achieve a mechanical bond with the next coat. To avoid sanding between coats, apply all of the coats in the same day (or apply each coat before the previous coat has fully cured). Tip off each coat in a direction perpendicular to the previous coat (e.g., first coat vertical, second horizontal, third vertical). After the final coat has cured thoroughly, wash and sand or wet-sand it to prepare for the final finish. If you are unable to apply all of the coats in the same day, allow the last coat to cure thoroughly and prepare the surface for recoating by first removing the amine blush.

On very large coating projects consider whether the job can be accomplished in one working day and, if necessary, how the coating operation could be efficiently split into multiple days. If, for example, you are applying six coats of epoxy to a large hull, it is a good idea to apply all six coats to half the hull on one day and six coats to the other half on the next day, rather than applying three coats to the entire hull on each day. Instead of having to wash and sand the entire hull to prepare for the next coat, you need only wash and sand the small overlap area at the edge of the first half. The project could be split into three or four day session depending on the number of helpers available and the conditions you are working in. The type of hardener, film thickness, temperature, humidity all affect epoxy's cure time and your recoating schedule. *Refer to the WEST SYSTEM User Manual & Product Guide for detailed information on handling epoxy.*

### Amine blush

Amine blush is a byproduct of the epoxy curing process and can appear as a wax-like film on cured epoxy surfaces. It is more noticeable on thicker films, cured in cool humid conditions. Blush formation is extremely low when using 207 Hardener.

The blush is water soluble and can easily be removed, but can clog sandpaper and inhibit subsequent bonding if not removed. To remove the blush, wash the surface with clean water and an abrasive pad, such as 3-M Scotch Brite™ 7447 General Purpose Hand Pads. Dry the surface with plain white paper towels to remove the dissolved blush before it dries on the surface. After washing with the abrasive pad, the surface should appear dull. Sand any remaining glossy areas with 80-grit sandpaper. Wet-sanding the surface will also remove the amine blush. If a release fabric is applied over the surface of fresh epoxy, all amine blush will be removed when the release fabric is peeled from the cured epoxy.

Epoxy surfaces that have not fully cured may be bonded to or *coated with epoxy* without washing or sanding. Before applying *coatings other than epoxy* (paints, bottom paints, varnishes, gelcoats, etc.), allow epoxy coated surfaces to cure fully, then wash and sand or wet-sand.

## Final surface preparation

Preparation for the final finish is just as important as it is for recoating with epoxy. The object of the final sanding is to smooth flaws in the epoxy coating and provide the appropriate “tooth” for the finish coating to key into. Allow the final epoxy coat to cure thoroughly and sand it to a smooth finish by either dry or wet sanding. Wet sanding will automatically remove the amine blush and it reduces sanding dust. If you prefer dry sanding, remove the amine blush (as described above) before beginning to sand.

The amount of sanding required will depend on how smoothly you applied the final epoxy coatings and which finish coating you choose. Since the epoxy is harder to sand than wood or fairing compound, power sanders can save a lot of work over hand sanding. An orbital or reciprocating sander with 80 or 100 grit paper works well for the initial sanding if the surface has stipple, sags or other unevenness. When the surface has reached an overall smoothness, switch to finer grits. Note that a dual-action (DA) orbital sander with coarser grit (e.g. 80 grit) will produce the same degree of smoothness as a reciprocating sander or hand sanding with a finer grit (e.g. 100 grit).

Complete the sanding with the appropriate grit for the type of coating to be applied. If a high-build or filling primer is to be applied, 80–100 grit is usually sufficient. 120–180 grit paper may be adequate for primers and high-solids coatings. Sanding with 220–400 grit paper will result in a high gloss finish for most paints or varnishes. Grit finer than this may not provide enough tooth. Keep in mind that light colored surfaces do not show sanding scratches as easily as dark surfaces. Sand to a finer grit finish under dark paints and clear finishes over dark wood. Always refer to the coating manufacturer’s specifications for the surface finish recommended for a particular coating. *Refer to Appendix A for more information on sanding equipment and abrasives.*

When you are satisfied with the smoothness, rinse the surface with fresh water. The rinse water should sheet evenly without beading or fisheyeing, indicating that there is no surface contamination. Dry the surface with plain white paper towels and allow to air dry completely before coating. To reduce the possibility of contamination, it is a good idea to apply the finish coating within 24 hours of the final sanding.

## Finish coatings

We’re using the term “finish coating” to distinguish it from the epoxy “barrier coating” and to include all coating materials (pigmented and non-pigmented) that can be applied over an epoxy barrier coat to form a protective system. Although modern linear polyurethane coatings are chemically quite different than traditional coatings, the term paint is generally used to refer to all pigmented coatings. The term varnish is often used to refer to all clear coatings. However, manufacturers and others distinguish between traditional varnishes and modern clear urethanes or clear polyurethanes.

Traditionally, paints and varnishes have been called on to protect structures from corrosion, oxidation and other forms of deterioration from exposure to air, sunlight, and water. However, paints and varnishes are not as effective for moisture protection as epoxy.

If buried in the ground, used only on interior surfaces or on surfaces otherwise protected from sunlight, an epoxy moisture barrier will remain effective indefinitely. However, under prolonged exposure to sunlight, an epoxy coating, like many other plastics, will chalk, turn yellow, and eventually break down. It is not intended to be an exposed finish coating.

When applied over an epoxy barrier coat, the function of a finish coating like paint or varnish is to decorate the surface and protect the epoxy from sunlight. In doing so, the finish coating extends the life of the epoxy moisture barrier, which, in turn provides a

stable base that extends the life of the finish coating. Together the two form a protective system far more durable than either coating by itself.

The ideal finish coating should not only look good and provide UV protection, it should be long lasting, tough, safe, easy to use, affordable, and compatible with epoxy. This section discusses these characteristics and the different types of coatings, to help you select the one best suited to your project.

## Characteristics of coatings

Over the years, advances in chemistry have improved the durability of finish coatings and the protection they offer. Paint and varnish have evolved into an extensive and increasingly confusing family of coatings and coating systems. When evaluating different coatings for your project, several basic coating characteristics should be considered.

### UV protection

Protection from sunlight is a primary consideration in the selection of a finish coating. The ultraviolet portion of sunlight (UV) is the primary catalyst in the degradation of epoxy and other plastics. The following factors affect a coating's ability to provide UV protection.

**Pigmented vs clear coatings**—Any coating that adheres to the surface and contains enough pigment will protect the epoxy barrier substrate from UV, for a time. Pigmented coatings work because opaque pigments reflect both visible and ultraviolet light before it passes through the coating film. Clear coatings and varnishes, on the other hand, are designed to allow light to pass through the film to the substrate and back out. They depend on “ultraviolet absorbers” to selectively trap radiation in the UV wavelength in the coating film before it reaches the barrier substrate. Without absorbers, UV would soon break down the substrate, causing the coating film to lose adhesion. UV absorbers alone are not as effective as pigments in blocking UV. Consequently, even the best clear coatings do not last as long as pigmented coatings, and require more frequent recoating. UV absorbers are added to pigmented and clear coatings for their own durability. For both types of coatings, long term UV protection of the barrier coat depends on how well the finish coating itself resists UV and keeps its pigments, or its shield of UV filters on the surface of the epoxy barrier coat.

**Glossy vs matte finishes**—Surface gloss is an important contributor to the UV resistance of both pigmented and clear coatings. A high gloss finish reflects a higher proportion of the light hitting the surface than a dull surface. Coatings are often rated or promoted by their ability to retain their gloss. Chalking, or loss of gloss, is one of the first indications that a finish is breaking down. As a surface loses its gloss, it reflects a smaller proportion of light, absorbs more UV, and the pace of the breakdown accelerates. Matte or satin versions of the same type of coating have a much shorter life than gloss versions, and are generally limited to interior surfaces, unless the surface is protected from UV in other ways. UV damage is cumulative. Covering when not in use or storing indoors to limit the hours of exposure will extend the life of matte and gloss finish coatings.

**Light vs dark colors**—The shade and color of the finish is also a factor in UV resistance. Darker shades absorb more ultraviolet than lighter shades, and some colors absorb more ultraviolet than others. White reflects more light and will last longer in sunlight than any color. It reflects all parts of the spectrum better, including infrared. This means the surface will remain cooler than a surface painted a dark color. All other things being equal, a white (especially a glossy white) coating will have the greatest longevity. A flat black coating will have the least. Cool colors (blues and greens) will last longer than warm colors (reds and browns). Clear coatings over light colored woods will outlast the same coating over dark colored woods. Remember! Sunlight is the enemy of epoxy.

### **Adhesion**

Paint adhesion relies on the mechanical grip of the paint keying into the sanding scratches in the epoxy's surface. Big scratches provide the best adhesion, but they may show through the finish. As a general rule, use no coarser than 80-grit with a mechanical sander and no coarser than 100-grit when hand sanding. The final grit you use depends on the type of paint and how thick a film will be applied. Try to use the coarsest paper that will not show scratches through the paint.

Surface contamination is a common cause of adhesion problems. After an epoxy barrier coat is properly sanded, protect the surface from all potential sources of contamination such as engine and heater exhaust, hand and finger prints, and rags cleaned or dried with fabric softeners. To reduce the possibility of contamination, begin the final coating application as soon as possible after the barrier coat preparation.

### **Compatibility**

Most types of coatings are compatible with epoxy. Thoroughly cured epoxy is an almost completely inert hard plastic. This means most paint solvents will not soften, swell or react with it. However, it is still a good idea to build a test panel to assure coating compatibility and work out application procedures before final application on a project. The test should duplicate the barrier coat finish, finish coating materials, application procedure and shop conditions. A lot of variables can affect the success of the final coating. Working out the bugs beforehand can save money, time and effort.

Note: Some types of one-part polyurethane coatings may not cure properly over epoxy. Incompatibility may be a result of a specific polyurethane catalyst reacting with or being affected by amine blush on the surface of the epoxy coating. Cure mechanisms vary from brand to brand. If a specific brand is incompatible, try a different brand or a different type of coating or use 207 Hardener. 207 Hardener is compatible with most coatings.

### **Hardness**

The hardness of a coating is another factor to consider in selecting a finish. Manufacturers refer to coating hardness in terms of a "pencil" hardness scale: 6B (the softest), to HB (the middle), to 6H (the hardest). Harder coatings are more resistant to wear and last longer than soft finishes. It is easier to remove flaws or scratches in harder finishes by rubbing or buffing. (Some coatings may harden enough to buff only after weeks or months of curing.)

The biggest advantage of a hard glossy coating is that it is easier to keep clean. Softer or more flexible coatings hold dirt easier and require more abrasion to clean. The more they are abraded, the more dirt they hold, and the more abrasion is required to clean them the next time. The trade off is that too hard a finish can chip or crack if it's applied to a flexible surface.

### **Application considerations**

The method of application is another important factor in the selection of a coating. Spray application is preferred if achieving the smoothest possible finish is the primary goal, but in some situations rolling, brushing or a combination of rolling and brushing may be your preferred or only choice. Spraying depends on access to proper equipment and an environment where overspray and solvent fumes can be controlled. Safety and health considerations are a major concern when spraying, especially with coatings like linear polyurethanes which require the applicator to wear special breathing equipment.

Roller/brush application is a good alternative to spraying. The same technique described for applying epoxy in Epoxy Barrier Coating (page 13) can be used to achieve a reasonably smooth finish with most coatings. There are a number of advantages to this method. The cost of transporting large projects to the nearest suitable location for spraying can be prohibitive. Most coatings are much less hazardous when they are not

atomized and overspray is eliminated, allowing you to work wherever temperature, humidity and airborne contaminants can be controlled or at least tolerated.

Automotive finishes are limited to spray application, but most marine or architectural coatings can be applied by spraying or by rolling or brushing. Marine linear polyurethane (LP) systems require different catalysts for brushing and spraying. Additional reducers and additives are available to control the rate of cure and other handling characteristics.

Coatings are adjusted to the proper consistency for either spraying or brushing by the addition of reducers or thinners. The amount of reducer/thinner added also affects the film thickness and the rate of cure. They may also soften the surface of some substrates, providing a chemical “bite” that improves adhesion. Reducers and thinners are blends of volatile solvents. Coatings may contain more than 20% solvents, most all of which evaporate into the air. Environmental concerns have restricted or will restrict the use of many of the more hazardous paint solvents. The number of highly solvated coatings is declining and the number of coatings with lower or safer solvents is increasing.

Selecting the right finish coating is becoming increasingly difficult given the changes underway in the coating industries. Marine coatings, architectural coatings, automotive and industrial coatings are all suitable for use over epoxy, although some will be much more suited to an individual project than others.

## Coating types

At one time “paint” referred to a protective and decorative coating consisting of a natural oil or resin binder and a solvent (together known as a vehicle), and pigments. When the solvent evaporated, the oils hardened to form a film, with the pigments suspended throughout. Although pigments have stayed pretty much the same, the natural oil and resin binders have been replaced or modified by a variety of synthetic resins and more complex film forming mechanisms.

Modern coatings offer a range of curing systems, handling characteristics and physical properties, from water-based latex to linear polyurethane. As durability and protection increase, cost, health hazards and difficulty of use often increase proportionately. The following types of coatings are listed in order of protection they offer, although physical properties can vary widely within each type. Coatings are commonly identified by the chemical names of their resin/oil and solvent vehicles.

### Waterborne coatings

Latex paint is the most common water-born coating and perhaps the safest and easiest to use of all coatings. Latex paints are compatible with epoxy and they do an adequate job of protecting the epoxy barrier from UV radiation. In many architectural applications latex paint may be the most suitable coating to use. Their durability is limited.

The number of waterborne coatings is increasing rapidly. In response to restrictions on volatile organic compound (VOC) emissions, massive research and development projects are currently underway to improve the protection and durability of waterborne systems. Water offers an obviously cleaner and safer alternative to the aromatics, ethers, esters and aliphatics used as coating systems solvents. Newer waterborne coatings include bottom paints, varnishes and top coats. They should be compatible with epoxy, although few have been available to test for compatibility or durability.

### Alkyd finishes

Alkyd resins are a synthetic polymer used as the base for a large family of coatings. They are usually modified with natural oils like linseed, soybean, cotton, or sunflower seed, or with other synthetic polymers like phenolics, acrylics or silicones. Alkyd finishes are one part coatings that cure as a result of solvent evaporation. They have been around for a long time and are among the lowest priced and easiest to use coatings.

They can be applied by brush, roller or spray equipment, and they thin and clean up with relatively safe solvents, like mineral spirits. They may be labeled as enamel, alkyd enamel, marine enamel, acrylic enamel, alkyd modified epoxy, traditional varnish and spar varnish. Within this group are a wide range of coatings with a variety handling characteristics and cured physical properties. Generally, they offer ease of application, low cost, low toxicity, and easy availability. Their disadvantages are low UV resistance and low abrasion resistance.

### **One-part polyurethanes**

There are two types of one-part finish coatings labeled polyurethane. The first type are urethane modified oils and urethane modified alkyds, which are similar to alkyd coatings in that they cure by oxidation when exposed to air. They also are similar in handling, application and cleanup, but offer much higher performance than traditional alkyd finishes. The second type of polyurethane falls between the solvent evaporation type and the crosslinking type of coating. It relies on solvent evaporation, but cures by a crosslinking reaction when exposed to humidity in the air. This type of polyurethane forms a durable film with good gloss retention and chemical resistance. They may be labeled urethane, polyurethane varnish, or polyurethane enamel. They offer easy application, cleanup and better physical properties than alkyds. They are also more expensive and may be incompatible with amine cure epoxy systems such as WEST SYSTEM.

### **Two-part epoxy paint**

Epoxy paints are available in one-part and two-part versions. Two-part epoxies offer many characteristics similar to the higher performance polyurethanes. They are durable and chemical resistant, but offer limited UV protection compared to the linear polyurethanes. Epoxy paints are useful as a stain resistant, easy to clean coating for interior surfaces like kitchens and bathrooms or in areas subject to oil or chemical spills.

### **Two-part polyurethanes**

Two-part linear polyurethane (LP) paints offer the most durable protection available. They are two part systems that cure by a crosslinking chemical reaction, initiated when a hardener (or converter) is mixed with the base resin. LP's shrink less than coatings that cure by solvent evaporation. They can be applied in thinner films and they hide more flaws. LP's are available as pigmented or clear coatings and offer excellent UV protection, gloss retention, abrasion resistance, plus compatibility with epoxy. However, they are expensive, require more skill to apply and present a greater health hazard than all other types of coatings.

Two-part polyurethanes contain isocyanates, which are hazardous, especially when sprayed. Spraying requires the use of forced air breathing equipment, making it more suited to professional application. However, good results are possible with roller/brush application at much safer vapor levels. Awlgrip and Sterling are two manufacturers of marine LP's that offer reducers for both roller/brush and spray application. Although automotive LP coatings are limited to spray application, they offer the same durability and protection as marine versions. They also offer a larger variety of colors (including metallics) and are available at local auto parts stores.

**Note!** An epoxy barrier coat is *required* over epoxy/410 Microlight Filler, if you are going to apply a solvented coating over the faired surface. Solvents in these coatings can affect 410 Filler and result in print through. Barrier coating is *recommended* over sanded epoxy/407 Filler to provide a consistent non-porous surface for finish coatings.

### **Other coatings**

Some coatings are formulated for specific functions—protection in a particular environment, as an interface between substrates and finish coatings or for certain application or handling traits. The following are examples of coatings designed for these kinds of limited applications.

**Bottom paint**—Bottom paints are available in a variety of formulations. Most bottom paints use copper as the biocide for algae and other forms of fouling. Some paint films are designed to wear away over time (ablatives types), exposing fresh copper compounds. Most bottom paint systems are compatible with epoxy and can be applied directly over a prepared epoxy barrier coat. If you are unsure of compatibility or have curing or adhesion problems with a specific bottom paint, use only a primer recommended for that bottom paint over the barrier coat. Follow the recommendations given for preparation of fiberglass surfaces. Other paints, including marine LP's and primers, are not recommended for use below the waterline.

**Primers**—Many primers are epoxy based because of epoxy's ability to adhere to a wide variety of materials and its compatibility with a wide variety of finish coatings. Primers are usually not needed to help a paint film bond to epoxy, although interfacing primers may be required with some specialized bottom paints and high-build primers are useful for hiding scratches or flaws in the substrate. If the instructions on your paint or varnish recommend a specially primed surface, follow the recommendations given for fiberglass preparation. Self-etching primers do not work well on an epoxy coating because of epoxy's chemical resistance.

**Polyester gelcoats**—Polyester gelcoat is a pigmented version of the resin used to build fiberglass boats and other products. Gelcoat is sprayed into a mold before the glass fabric and resin are applied to provide a smooth pre-finished surface when the part is removed from the mold. It is not often used as a post-production finish coating, but it can be applied over epoxy and is useful in some repair situations. Refer to *002-550 Fiberglass Boat Repair & Maintenance*, published by West System, for detailed information on patching gelcoat over an epoxy repair.

## Final notes

A few paints and varnishes do not cure well over the epoxy. If the coating does not dry in the specified time or flow on evenly, try a different brand or use a primer.

Follow all instructions from the coating systems manufacturer. It is a good idea to make a test panel to evaluate the degree of surface preparation required, and the compatibility and handling characteristics of the finish system.

Be sure to familiarize yourself with the use and handling of WEST SYSTEM epoxy products by reading the *WEST SYSTEM User Manual & Product Guide*.

For structural repairs to wood or fiberglass, refer to *002-970 Wooden Boat Restoration & Repair*, *002-550 Fiberglass Boat Repair & Maintenance*, or *002-650 Gelcoat Blisters—Diagnosis, Repair & Prevention*.

Additional Reading:

*Fine Boat Finishes* by Paul and Marya Butler is an excellent marine oriented guide to materials and techniques used to produce professional quality finishes.

*The Gougeon Brothers on Boat Construction* discusses many aspects of fairing and includes an extensive chapter on lofting.



# Appendix

## Appendix A Tools and materials

### Abrasives

Abrasives, specifically the different types of sandpaper, are the primary tool for removing material in fairing and finishing operations. Sandpaper is available in a variety of forms, grits and composition.

The abrasive mineral particles are bonded to a cloth or paper backing, in sheets, discs and belts. 9" x 11" sheets are the most common form. They can be cut or folded to a convenient size for hand sanding or to fit pad sanders. Narrower sheets are sized for machine sanders. 2¾" x 16½" or 17½" adhesive backed sizes are designed for air file sanders, but also work well on fairing boards or blocks. Discs come in a variety of diameters. 5", 6" and 8" are the most common and are available with pressure sensitive adhesive backs. Some manufacturers offer hook and loop type discs and corresponding pads. Plain backed papers can be mounted to blocks or boards with contact adhesive.

Sandpaper can come in "open coat" or "closed coat". Open coat means the mineral particles are spread out more and are less likely to "load up" or clog as easily as closed coat papers. Sandpaper is identified by the abrasive mineral on the face. Each mineral has different qualities of hardness (cutting ability) and toughness (wearing ability). The following types are most often used for fairing and finishing:

**Zirconia Alumina**—Fairly aggressive cutting action, very long wearing (toughest), useful for rough fairing.

**Aluminum Oxide**—Aggressive cutting action, long wearing, good all around paper for rough and finish sanding.

**Silicon Carbide**—Very aggressive cutting action (hardest), moderately long wearing, useful for finishing and wet-sanding (with waterproof paper).

Grit refers to the mineral particle size and generally determines the amount of material a paper will remove and how smooth it will leave the surface. The following grits are useful for fairing and finishing:

**36 to 50 grit**—Rough fairing depending on the type and amount of material.

**50 to 80 grit**—Local fairing and preparation for the epoxy barrier coat.

**80 to 100 grit**—Preparing the epoxy barrier coat if a high-build or filling primer is to be applied.

**120 to 180 grit**—Preparing the epoxy barrier coat for primers and high-solids coatings.

**220 to 400 grit**—Preparing the epoxy barrier coat for most paints or varnishes and sanding between coats of paint or varnish. The thinner the coating film thickness, the finer the grit.

### Fairing fillers

WEST SYSTEM 407 Low-Density and 410 Microlight™ fillers are blended to create fairing compounds when mixed with epoxy. 407 filler is a phenolic microballoon based mixture. It sands and carves easily when cured, and is strong enough to be used in some structural applications. 407 can be mixed to a stiffer consistency than 410. 410 Microlight is about three times lighter and about 25% easier to sand than 407. It mixes easier and is more economical. However, 410 is not recommended under dark paint or other surfaces subject to high temperatures. 407 filler is a better choice for thicker applications or applications requiring more impact or abrasion resistance.

Fairing compound is generally mixed to the consistency of peanut butter. The more filler added to the epoxy—the stiffer the mixture and the easier it is to sand. Because epoxy is thinner at higher temperatures, it takes more filler to make a specific consistency at higher temperatures than it does at lower temperatures.

### Mixing large quantities

Approximate quantity of mixed epoxy to produce a "peanut butter" consistency		
Fairing Filler	Package size	Epoxy quantity
407-5	4.0 oz	.3 qt
407-15	12.0 oz	1.0 qt
407-B	14.0 lb	3.7 gal
410-2	2.0 oz	.7 qt
410-7	5.0 oz	1.8 qt
410-B	4.0 lb	5.6 gal

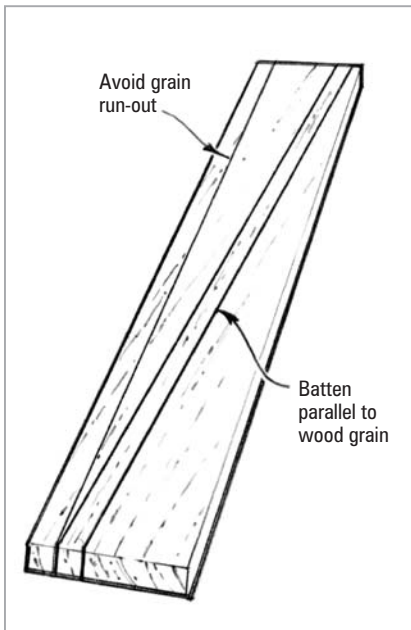
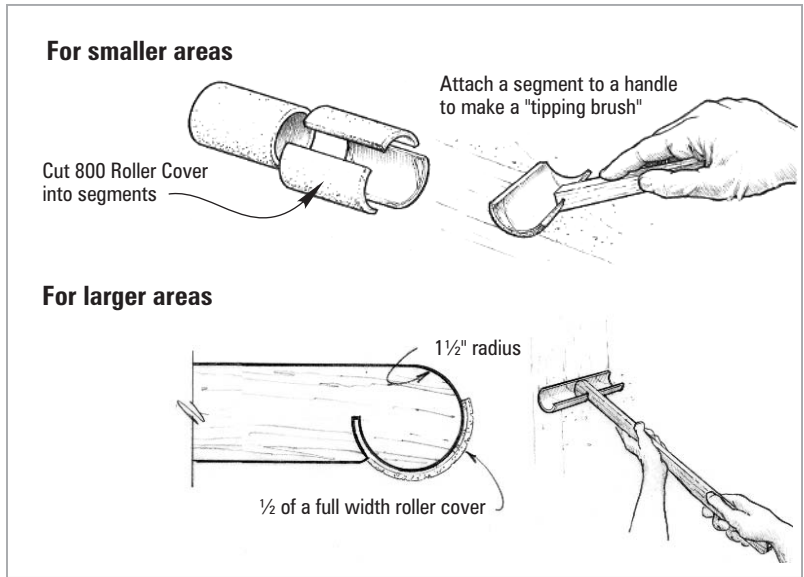
Use the above guide as a starting point for determining the proportion of epoxy and filler. Increase quantities of mixed epoxy and filler proportionately. Monitor and record quantities and modifications so workers have a gauge to assure greater accuracy and speed of mixing. Mixing and applying large quantities of epoxy requires an efficient, coordinated operation.

First, stir resin and hardener thoroughly in a mixing pot. Then pour the mixed epoxy over an equal volume of filler in a container that holds at least four times the volume of the mixed epoxy. Using a stiff wooden paddle, stir the mixture until it reaches a smooth consistency. Continue stirring and adding filler, gradually thickening the mixture. When you arrive at stiff (peanut butter) consistency, dump the material onto a 2' x 2' piece of scrap ½" thick plywood. Spread the fairing compound out on the plywood to make it easier to see dry or unmixed areas and allow you to better judge the consistency. This also increases the material's surface area, allowing heat to dissipate and providing more working time. Use 206 or 209 Hardener to provide more working time at room temperature or adequate working time at warmer temperatures. Apply the mixture as soon as possible after mixing.

**Roller cover brushes**

Roller cover brushes are used to “tip-off” coats of epoxy or paint. Tipping removes bubbles, stipple and roller marks, and helps the coating to flow out evenly. Cut a WEST SYSTEM 800 Roller Cover into equal segments. The cover can be first cut in half to make six 3 1/2" wide brushes per cover. Fasten a handle to the cover by inserting a flat edge of the cover into a slot cut in the end of a short stick of scrap wood.

A larger brush can be made by cutting a cover in half lengthwise and fastening the halves to a larger handles.

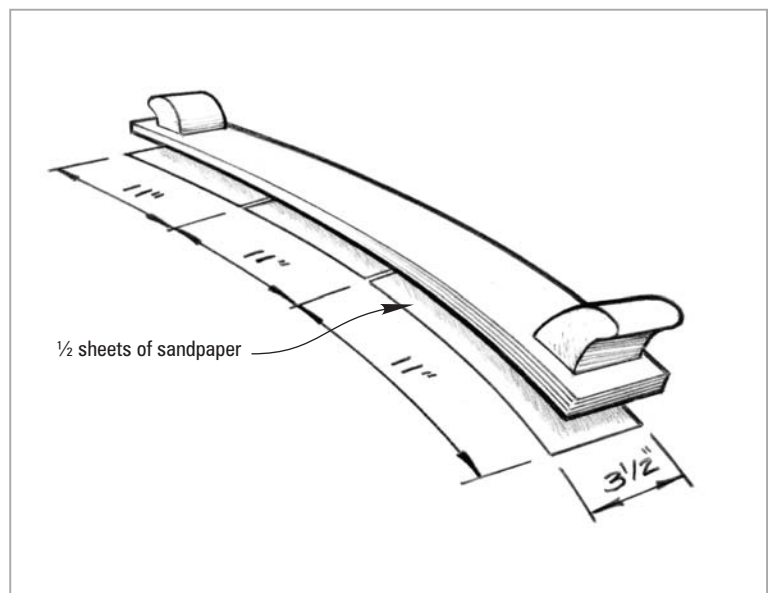


**Making a batten**

The simplest battens are produced from straight-grained softwood like pine or fir. Select stock with no grain run-out and cut the batten parallel to the grain, rather than the edge of the stock. You may need several battens of different lengths and cross sections if you are fairing a large hull or a variety of surfaces. A long batten may be between 3/4" and 1 1/4" square (depending of the flexibility of the wood and the shape of the hull) and as long as the length of the hull. It should be thin enough to conform to the overall shape, but stiff enough to bend in a fair curve. A short batten, up to 6' long, is useful for fairing smaller areas. It may be up to 3/4" square or as thin as 1/4" x 3/4" to conform to tighter curves, such as the turn of the bilge. If joining shorter lengths of wood to make a long batten, use long scarf joints (20:1) to avoid hard spots. Painting the batten a flat color can reduce any visual deception from the wood grain.

**Making a fairing board**

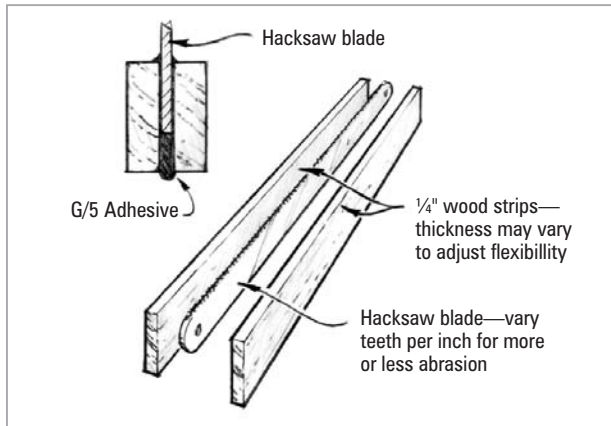
A long fairing board can be made of 1/4" to 1/2" plywood, depending on the curve of the surface to be faired. The length of the board is a multiple of 11" to make economical use of a 7 1/2" x 11" sheet of sandpaper. The width of the board is 3 1/2" or half a sheet. Handles may be bonded to the ends of the board for greater control. On larger yachts, 4' to 6'-long boards may be necessary when a truly fair hull is the goal. Unfortunately, boards this size can be very fatiguing to use. Specially constructed boards can reduce weight by 50% or more. Just like any other tool, boards designed for specific tasks translate into better quality surfaces with less effort.



### Making a fairing file

Hacksaw blades can be modified and used for fairing. Sanding the cured epoxy with sanding boards can be slow work. A new hacksaw blade will easily cut through the low-density filler and occasional high spots in the fiberglass.

Clamp the hacksaw blade between two ¼"-thick wooden strips. The strips provide a handle and add stiffness to the blade, but are flexible enough to bend slightly over curved surfaces. Round the corners of the wooden strips with sandpaper, to make it comfortable to hold. Hold the blade and strips together with epoxy or G/5, Five Minute Adhesive. Keep the glue out of the saw teeth while bonding the wooden strips to the saw blade.



For surfaces with lots of curve, add thinner strips of wood to each side of the hacksaw blade. If it's still too stiff, a few strokes of a hand plane on each side will fine tune flexibility.

Some industrial or power hacksaw blades may be stiff enough to use without adding wood. When doing a lot of fairing, it is helpful to have a variety of these tools, to allow a change of handholds to reduce fatigue.

Just like sandpaper, hacksaw blades offer differing abrasive qualities. A 6 to 10 TPI (teeth per inch) blade will offer good coarse fairing capability. A 16 to 20 TPI blade offers medium fairing capability and the 28 to 32 TPI offers fine fairing capability.

To work this modified tool effectively, hold it so the saw teeth are against the surface to be faired. Lean the tool over slightly at a 10° to 20° angle and push the tool across the surface in a direction that is diagonal to the length of the tool. Avoid pushing in a direction parallel to the tool length, because the saw blade will cut a slot in the surface. Think of the modified saw as a file that is used in a diagonal direction to maximize the cut. Experiment with the angle at which you push or pull the tool across the surface.

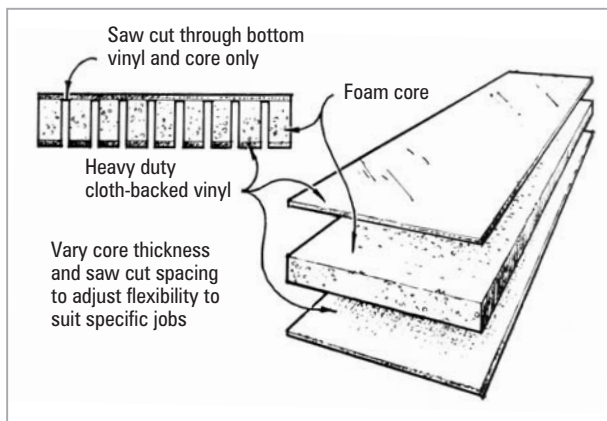
As with sandpaper, it is best to fair the surface in opposing directions on a diagonal. To do this, turn the saw around so the teeth are facing the other direction and repeat the fairing process working in the opposite direction. Fairing in opposing directions will quickly establish a fair surface and help to better maintain fairness.

### Making a flexible sanding board

Long, stiff sanding boards work well on gently curving structures. However, where surfaces are more tightly curved, very little of the sanding board will actually touch the surface.

Make a flexible sanding block for these surfaces by gluing ⅜"-thick redwood to conveyor belt material. Scuff the belt material up so it will bond with epoxy. After the epoxy cures, make saw cuts parallel to the length of the redwood on ½" apart. Make the cuts just deep enough to pass through the wood but not into the conveyor belt. These cuts allow the sanding board to conform to concave or convex surfaces across the width of the sanding board while remaining stiff along the length. By varying the thickness of the wood and the distance between saw cuts, you can adjust the stiffness and edgewise flexibility of the tool.

Make a waterproof version for wet sanding by using of two skins of flexible conveyor belting separated by a layer of low-density closed-cell foam core. Glue ⅛" thick conveyor belting to both sides of the foam core, creating a stiff laminate. Like the wooden version, make deep saw cuts parallel to the length of the sanding board, going through the first skin and core but not into the second skin.



Belting materials, core thickness and cut spacing can be varied to achieve different results for specific jobs. Sizes can range from 1" thick by 6" wide by 36" long, to much smaller versions ¼" thick by 1" wide by 2" long. A thickness that works well for 1/3 to 1/2 sheet of sandpaper is ½" thick, made of ⅜" thick foam core separated by two layers of belting. These sanding blocks work particularly well with adhesive-backed sandpaper.

## Appendix B Lofting foil shapes for rudders and keels

Whether you are going to build an airfoil from scratch or fair an existing foil with a template as described in the *Template guide method* on page 9, you have to establish the section profile accurately.

Airfoils are cambered sections that are designed to produce lift (with minimum drag) as they operate in a fluid (air or water). Certain sections produce the most lift with the least amount of drag for given conditions of fluid density and foil speed.

When a designer chooses a foil section for a particular design, that section is often not produced to a close tolerance. Optimization of the airfoil section translates into measurable performance and handling benefits.

Airfoil sections of all NACA (National Advisory Committee for Aeronautics) families are obtained from dimensions off the centerline from specific station points. Station points begin at zero at the nose. The stations are spaced more closely in the forward third of the foil section's chord length. This area carries more shape, thus requiring more reference points to define it.

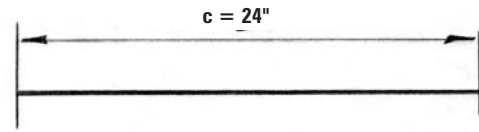
*Chord line* is defined as the straight line connecting the leading and trailing edges (or centerline). *Station locations* are expressed as a percentage, measured from the forward #0 station of the chord line. *Chord thickness* is described as a percentage of chord line, measured in half breadths at a particular station.

### NACA 0012 Basic Thickness form

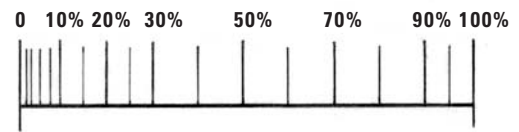
$x$ (per cent $c$ )	$y$ (per cent $c$ )	$(v/V)^2$	$v/V$	$\Delta v_s/V$
0	0	0	0	1.988
0.5	.....	0.640	0.800	1.475
1.25	1.894	1.010	1.005	1.199
2.5	2.615	1.241	1.114	0.934
5.0	3.555	1.378	1.174	0.685
7.5	4.200	1.402	1.184	0.558
10	4.683	1.411	1.188	0.479
15	5.345	1.411	1.188	0.381
20	5.737	1.399	1.183	0.319
25	5.941	1.378	1.174	0.273
30	6.002	1.350	1.162	0.239
40	5.803	1.288	1.135	0.187
50	5.294	1.228	1.108	0.149
60	4.563	1.166	1.080	0.118
70	3.664	1.109	1.053	0.092
80	2.623	1.044	1.022	0.068
90	1.448	0.956	0.978	0.044
95	0.807	0.906	0.952	0.029
100	0.126	0	0	0

L.E. radius: 1.58 per cent  $c$

1. Establish overall chord line length ( $c$ ); our example is 24".

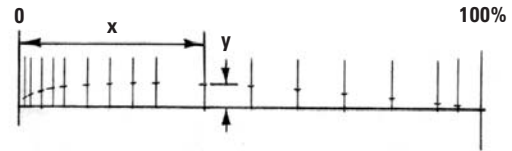


2. Refer to NACA 0012 Basic Thickness Form. Calculate and mark the station locations ( $x$ ) which are a percent-



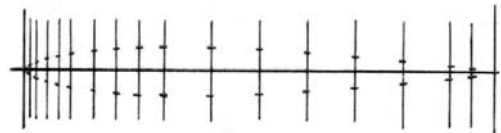
age of the overall chord line length, measured from 0%.

3. Calculate and mark the  $y$  dimensions (thickness from



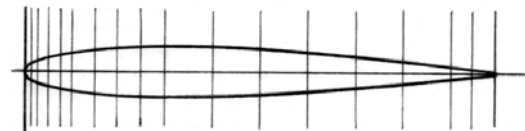
the chord line) at each station.

4. Duplicate the  $y$  dimension points on the other half of



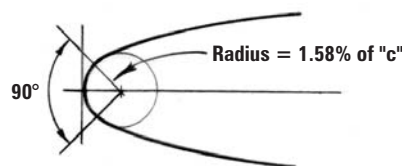
the foil.

5. Connect the plotted points with a batten or ship's



curve.

6. Lay out the leading edge line. The actual line is a 90-degree segment of a circle drawn tangent to #0, bisected



## Appendix C Problem solving

This guide is designed to help identify and prevent potential problems associated with using WEST SYSTEM epoxy. If the solutions described here do not resolve the problem, call the West System technical staff.

PROBLEM	POSSIBLE CAUSES	SOLUTION
The epoxy mixture has not cured after the recommended cure time has passed.	Off ratio—too much or too little hardener will affect the cure time and thoroughness of the cure.	<ol style="list-style-type: none"> <li>1. Remove epoxy. Do not apply additional material over non-curing epoxy. See Removing epoxy, page 28.</li> <li>2. Check correct number of pump strokes—use equal strokes of resin and hardener. DO NOT add extra hardener for faster cure!</li> <li>3. Check for correct pump (5:1 or 3:1 ratio) and pump group size (Group B resin and Group B hardener).</li> <li>4. Check pump ratio (see pump instructions). See User Manual—Dispensing, page 4.</li> </ol>
	Low temperature—epoxy mixtures cure slower at low temperatures.	<ol style="list-style-type: none"> <li>1. Allow extra curing time in cool weather.</li> <li>2. Apply heat to maintain the chemical reaction and speed the cure. NOTE! Unvented kerosene or propane heaters can inhibit the cure of epoxy and contaminate epoxy surfaces.</li> <li>3. Use a faster hardener, designed to cure at lower temperatures.</li> </ol> See User Manual—Understanding cure time, page 3.
	Insufficient mixing.	<ol style="list-style-type: none"> <li>1. Remove epoxy. Do not apply additional material over non-curing epoxy. See Removing epoxy, page 28.</li> <li>2. Mix resin and hardener together thoroughly to avoid resin rich and hardener rich areas.</li> <li>3. Add fillers or additives <i>after</i> resin and hardener have been thoroughly mixed.</li> </ol> See User Manual—Mixing, page 4.
	Incorrect products.	<ol style="list-style-type: none"> <li>1. Remove epoxy. Do not apply additional material over non-curing epoxy. See Removing epoxy, page 28.</li> <li>2. Check for proper resin and hardener. Resin will not cure properly with other brands of hardener or with polyester catalysts.</li> </ol>
Bond failure.	Insufficient cure.	See above.
	Resin starved joint—epoxy has wicked into porous surfaces leaving a void at the joint.	Wet out bonding surfaces before applying thickened epoxy. Re-wet very porous surfaces and end grain. See User Manual—Two-step bonding, page 7.
	Contaminated bonding surface.	Clean and sand the surface properly. Sand wood surfaces after planing or joining. See User Manual—Surface preparation, page 6.
	Bonding area too small for the load on the joint.	Increase bonding area by adding fillets, bonded fasteners or scarf joints.
	Too much clamping pressure squeezed epoxy out of the joint.	Use just enough clamping pressure to squeeze a small amount of epoxy from the joint. See Clamping, page 28.
Clear coating turned cloudy.	Moisture from condensation or very humid conditions reacts with components in uncured hardener.	<ol style="list-style-type: none"> <li>1. Apply moderate heat to partially cured coating to remove moisture and complete cure.</li> <li>2. Use 207 Hardener for clear coating applications and for bonding thin veneers where epoxy may bleed through to the surface.</li> </ol>
	Entrapped air from aggressive roller application.	<ol style="list-style-type: none"> <li>1. Apply coating at warmer temperature—epoxy is thinner at warmer temperatures.</li> <li>2. Apply epoxy in thin coats.</li> <li>3. Apply moderate heat to release trapped air and complete cure. See User Manual—Out-gassing caution, page 4.</li> </ol>
Waxy film appears on surface of cured epoxy.	Amine blush forms as a result of the curing process.	Blush formation is typical. Remove with water. See Amine blush, page 15.
Hardener has turned red after several years storage.	Moisture in contact with hardener and metal container.	Red color is a normal condition. It will not affect epoxy handling or cured strength. Avoid using for clear coating or exposed areas where color is not desired.

PROBLEM	POSSIBLE CAUSES	SOLUTION
Runs or sags in coating.	Epoxy applied too thick.	<ol style="list-style-type: none"> <li>1. Use 800 Roller Covers and roll the coating out into a thinner film. A thin film will flow out much smoother than a thicker film after it is tipped off with the foam roller brush.</li> <li>2. Warm the epoxy to thin it or apply the coating at a warmer temperature.</li> </ol> See Epoxy barrier coating, page 13.
	Coating curing too slowly.	<ol style="list-style-type: none"> <li>1. Apply the coating at a warmer temperature.</li> <li>2. Warm the resin and hardener before mixing to speed the cure in cool weather.</li> <li>3. Switch to a faster hardener, if possible.</li> </ol> See User Manual—Controlling cure time, page 3.
Fairing compound (epoxy/407 or 410 mixture) sags and is difficult to sand.	Fairing material not thick enough.	<ol style="list-style-type: none"> <li>1. Add more filler to the mixture until it reaches a “peanut butter” consistency—the more filler added, the stiffer and easier it will be to sand.</li> <li>2. Allow the wet-out coat to gel before applying the fairing material to vertical surfaces.</li> </ol>
Paint, varnish or gelcoat will not set up over epoxy.	Epoxy not completely cured.	Allow the final epoxy coat to cure thoroughly. Allow several days if necessary for slow hardeners at cooler temperatures. Apply moderate heat to complete the cure if necessary. See User Manual—Controlling cure time, page 3.
	Paint incompatible with epoxy.	<ol style="list-style-type: none"> <li>1. Use a different type of paint. Some paints and varnishes may be incompatible with some hardeners. If unsure, test for compatibility on a coated piece of scrap material.</li> <li>2. Use 207 Hardener. It is compatible with most paints and varnishes.</li> </ol>
	Epoxy surface not thoroughly prepared.	Remove the amine blush and sand the surface thoroughly before applying paints or varnishes. See Final surface preparation, page 16.
Epoxy became very hot and cured too quickly.	Batch too large, or left in mixing pot too long.	<ol style="list-style-type: none"> <li>1. Mix smaller batches.</li> <li>2. Transfer the mixture to a container with more surface area, immediately after mixing.</li> </ol> See User Manual—Understanding cure time, page 3, Dispensing and mixing, page 4.
	Temperature too warm for the hardener.	Use 206 Slow or 209 Extra Slow Hardener in very warm weather.
	Application too thick.	Apply thick areas of fill in several thin layers.
Bubbles formed in coating over porous material (bare wood or foam).	Air trapped in the material escapes through coating (out-gassing) as the material’s temperature is rising.	<ol style="list-style-type: none"> <li>1. Coat the wood as its temperature is dropping—after warming the wood with heaters or during the later part of the day.</li> <li>2. Apply a thinner coat, allowing air to escape easier.</li> <li>3. Tip off the coating with a roller cover brush to break bubbles.</li> </ol> See User Manual—out-gassing caution, page 4.
Pinholes appear in epoxy coating over abraded fiberglass or epoxy.	Surface tension causes epoxy film to pull away from pinhole before it gels.	After applying epoxy with 800 Roller Cover, force epoxy into pinholes with a stiff plastic or metal spreader held at a low or nearly flat angle. Recoat and tip off coating after all pinholes are filled.
Fisheyeing in coating.	Contamination of the coating or surface or improper abrasion for the coating	<ol style="list-style-type: none"> <li>1. Be sure mixing equipment is clean. Avoid waxed mixing containers.</li> <li>2. Be sure surface is properly prepared. Use proper grit sandpaper for the coating, e.g. 80-grit for epoxy. See paint or varnish manufacturer’s instructions for proper surface preparation. After surface is prepared, avoid contamination—fingerprints, exhaust fumes, rags with fabric softener (silicone). Coat within hours of preparation. After wet sanding, rinse water should sheet without beading (beading indicates contamination). Wipe with appropriate solvent and re-rinse until rinse water no longer beads. Contact West System Technical staff if you have additional questions.</li> </ol>

## Appendix C Problem solving notes

### Removing epoxy

**Removing uncured or non-curing epoxy.** Uncured epoxy is removed as you would spilled resin. Scrape as much material as you can from the surface using a stiff metal or plastic scraper—warm the epoxy to lower its viscosity. Clean the residue with lacquer thinner, acetone, or alcohol. Be sure the solvent you choose does not attack the substrate. Follow safety warnings on solvents, and provide adequate ventilation. After recoating wood surfaces with epoxy, it's a good idea to brush the wet epoxy (in the direction of the grain) with a wire brush to improve adhesion. Allow solvents to dry before recoating.

**Removing fiberglass cloth applied with epoxy.** Use a heat gun to heat and soften the epoxy. Start in a small area near a corner or edge. Apply heat until you can slip a putty knife or chisel under the cloth (about 200°F). Grab the edge with a pair of pliers and pull up on the cloth while heating just ahead of the separation. On large areas, use a utility knife to score the glass and remove in narrower strips. Resulting surface texture may be coated or remaining epoxy may be removed as follows.

**Removing cured epoxy coating.** Use a heat gun to soften the epoxy (200°F). Heat a small area and use a paint or cabinet scraper to remove the bulk of the coating. Sand the surface to remove the remaining material. Provide ventilation when heating epoxy. Be sure the temperature will not affect the substrate.

### Clamping

Any method of clamping is suitable as long as the parts to be joined are held so that movement will not occur. Don't use so much pressure that you squeeze all of the epoxy out of the joint. Common methods include spring clamps, "C" clamps and adjustable bar clamps, heavy rubber bands cut from inner tubes, nylon-reinforced packaging tape, applying weights, and vacuum bagging. When placing clamps near epoxy-covered areas, cover clamp pads with duct tape, or use polyethylene sheeting or release fabric under the clamps so they don't inadvertently bond to the surface. Staples, nails or drywall screws are often used where conventional clamps will not work. Any fasteners left in should be of a non-corroding alloy such as bronze. In some cases the thickened epoxy or gravity will hold parts in position without clamps.

### Thinning epoxy

There are epoxy-based products specifically designed to penetrate and reinforce rotted wood. These products, basically an epoxy thinned with solvents, do a good job of penetrating wood. But the solvents compromise the strength and moisture barrier properties of the epoxy. WEST SYSTEM epoxy can be thinned with solvents for greater penetration, but not without the same compromise in strength and moisture resistance. Acetone and lacquer thinner have been used to thin WEST SYSTEM epoxy and duplicate these penetrating epoxies with about the same effectiveness. If you chose to thin the epoxy, keep in mind that the strength and moisture protection of the epoxy are lost in proportion to the amount of solvent added.

There is a better solution to get good penetration without losing strength or moisture resistance. We recommend moderate heating of the repair area and the epoxy with a heat gun or heat lamp. The epoxy will have a lower viscosity and penetrate more deeply when it is warmed and contacts the warmed wood cavities and pores. Although the working life of the epoxy will be considerably shortened, slower hardeners (206, 207, 209) will have a longer working life and will penetrate more than 205 Hardener before they begin to gel. When the epoxy cures it will retain all of its strength and effectiveness as a moisture barrier, which we feel more than offsets any advantages gained by adding solvents to the epoxy.

## Index

### A

abrasives, 22  
 Adhesion, paint, 18  
 alkyd finishes, 19  
 aluminum oxide, 22  
 Amine blush, 15  
 application methods, finish coatings, 18  
 automotive finishes, 19

### B

batten, 3  
 Batten guide method, 8  
 batten, making, 23  
 bottom paints, 21

### C

chalk stick, 3  
 Clamping, 28  
 clear coatings, 17  
 closed coat sandpaper, 22  
 Coating compatibility, 18  
 Coating hardness, 18  
 Coating types, 19  
 cross-grain scratches, 4

### D

dark colors, 17  
 dust warning, 3

### E

Epoxy barrier coating, 13  
 epoxy paint, 20

### F

fair level, 2  
 fair, definition, 1  
 fairing batten, 3  
 fairing board, 4

fairing board, making, 23  
 fairing compound, preparing, 5  
 Fairing fillers, 22  
 Final Fairing, 1 - 12  
 Final surface preparation, 16  
 Finish coatings, 16  
 Finishing, 13 - 21  
 Fish-eyeing, 27  
 Flexible sanding board, making, 24

### G

gelcoats, 21  
 Glossy finishes, 17  
 grits, sanding, 22  
 Guide fairing methods, 7

### H

high areas, removing, 3

### K

keels, fairing, 10  
 keels, lofting, 25

### L

light colors, 17  
 Local fairing, 13  
 lofting, 1  
 Lofting foil shapes, 25  
 low areas, filling, 4

### M

matte finishes, 17  
 Mixing large quantities, 22

### N

Notched trowel method, 6

### O

open coat sandpaper, 22  
 Overview, 1

### P

Pigmented coatings, 17  
 polyurethanes, 20  
 preparation for finish coating, 16  
 primers, 21  
 Problem solving, 26

### R

Recoating, 15  
 Removing epoxy, 28  
 Removing fiberglass cloth, 28  
 Roller cover brushes, 23  
 rudders, fairing, 10  
 rudders, lofting, 25

### S

silicon carbide, 22  
 Standard fairing method, 5  
 Standard method of filling, 5  
 stripper canoe, 3

### T

Template guide method, 9  
 Template transfer, 12  
 Thinning epoxy, 28  
 Tipping off, 15  
 Tools and materials, 22

### U

User Manual & Product Guide, 5  
 UV protection, 13,, 17

### W

waterborne coating, 19

### Z

zirconia alumina, 22



## Additional building and repair information available from West System Inc.

### **Publications** 002-950 **WEST SYSTEM® User Manual & Product Guide**

The primary guide to safety, handling and the basic techniques of epoxy use. It includes a complete description of WEST SYSTEM epoxy resin, hardeners, fillers, additives, reinforcing materials tools, supplies and publications.

### **002 The Gougeon Brothers on Boat Construction**

This book is a must for anyone building a boat or working with wood and WEST SYSTEM epoxy. Includes extensive chapters on composite construction techniques, materials, lofting, safety and tools, with many illustrations, diagrams and photographs.

### **002-550 Fiberglass Boat Repair & Maintenance**

A complete guide to repair fiberglass boats with WEST SYSTEM epoxy. Includes illustrated procedures for structural reinforcement, cored and non-cored laminate repair, hardware installation, keel repair, and teak deck installation

### **002-970 Wooden Boat Restoration & Repair**

An illustrated guide to restore the structure, improve the appearance, reduce the maintenance and prolong the life of wooden boats with WEST SYSTEM epoxy. Includes information on dry rot repair, structural framework repair, hull and deck planking repair, hardware installation with epoxy and protective coating.

### **002-650 Gelcoat Blisters-Diagnosis, Repair & Prevention**

A guide for repairing and preventing gelcoat blisters in fiberglass boats with WEST SYSTEM Epoxy. Includes an analysis of the factors that contribute to blister formation and illustrated steps for preparation, drying, repairing and coating for moisture protection.

### **002-150 Vacuum Bagging Techniques**

A step-by-step guide to vacuum bag laminating techniques for bonding wood, core materials and synthetic composites with WEST SYSTEM Epoxy. Discusses theory, molds, equipment and techniques used to build composite structures.

### **Videos** 002-892 **Basic Application Techniques**

A video primer on WEST SYSTEM Epoxy Products and their use. Includes safety procedures and application tips for coating, bonding and fairing. VHS-20 min.

### **002-894 Fiberglass Repair with WEST SYSTEM Brand Epoxy**

A guide to structural repair on fiberglass boats. Covers repairs to cored and non-cored panels and how to apply gelcoat over epoxy repairs. VHS-20 min.

### **002-896 Gelcoat Blister Repair with WEST SYSTEM Brand Epoxy**

A guide for repairing and preventing gelcoat blisters on fiberglass boats. Includes an analysis of the factors contributing to blister formation and steps for preparation, drying, repairing and coating for moisture protection. VHS-16 min.

## 002-740 **Final Fairing & Finishing**

Published by  
West System Inc.  
P.O. Box 665  
Bay City, MI 48707 USA  
866-937-8797  
www.westsystem.com